



**SEVENTH FRAMEWORK PROGRAMME  
THEME ENERGY.2009.3.2.2  
Biowaste as feedstock for 2nd generation**

**VALORGAS**

**Final Publishable Summary Report**

Project acronym: **VALORGAS**

Project full title: **Valorisation of food waste to biogas**

Grant agreement no.: 241334

## Executive summary

The research encompassed all aspects of biogas production from food waste using the anaerobic digestion process. The main aim has been to achieve a stable digestion process with optimised systems for the collection of food waste and the beneficial use of process residues, set in the context of maximising the net energy gains from the system as a whole.

The results are reported in the context of the project objectives and the parameters used for verification of performance, both of which are presented in the introduction. The main scientific and technical results are summarised in 13 sections in which information from different work packages has been assembled to provide a cohesive and integrated interpretation of the results.

Compositional physical and chemical analysis of source segregated municipal food waste showed a remarkable similarity across Europe although there were regional differences in the major food types, particularly those supplying carbohydrate, and in beverage preferences. The results confirmed that the high protein content was likely to lead to high ammonia concentrations in the digestion process. Different levels of contamination were also found and these could be related to the collection schemes employed. Information about these across Europe was obtained in a unique web-based survey and the results used to assess current food waste collection activity in each country. Optimisation of food waste collection systems was done using a mechanistic model which was further developed to give a powerful software tool that can be used for both scheme development and performance assessment. This has been fully validated and is now publically available. The potential for AD was assessed at different scales and particular attention paid in the smaller size range to public and private communities.

Issues of digester stability as a result of ammonia toxicity were approached in a number of ways and solutions were found in each of the directions taken. Understanding of process microbiology and reaction pathways allowed manipulation of these through supplementation with Co and Se, allowing a more ammonia-tolerant hydrogenotrophic methanogenic population to dominate the system. The shifts in population were successfully monitored using Fluorescent in-situ hybridisation (FISH), advanced gene sequencing techniques, and  $^{14}\text{C}$  radiolabelling. Using this approach we were able to demonstrate process stability in a full-scale digestion plant. To operate at thermophilic temperatures it was necessary to remove ammonia from the digester, and both sidestream stripping columns and vacuum evaporation proved successful. This opened the possibility of developing a 2-phase process for hythane production which was successfully demonstrated. Once problems of digester instability were overcome, the readily biodegradable nature of food waste with its high specific methane potential gave excellent volumetric methane productivity especially when applied at high loading. Because of the ease of degradation the pre-treatment technologies tested (cellruptor and autoclaving) could not improve the process, but unexpected results using the autoclave opened up interesting potential niche markets for this technology.

Mass and energy balances determined at two full-scale digestion plants, in England and Portugal, both gave positive energy balances with the differences accounted for by design aspects to meet local requirements for by-product reuse. Data from these and other AD plants, together with a wealth of published information on digestion systems was used to develop the ADtool for comprehensive assessment of the energy and carbon balance of a digestion scheme: this is now publically available in a spreadsheet version, and will be released as a software package once beta testing is complete. Upgrading of biogas to vehicle fuel-grade biomethane was carried out in the EU and in India, with both teams successfully developing appropriate small-scale upgrading and vehicle fuelling technologies. These were fully tested and evaluated in terms of efficiency, product quality and compliance to standards. Digestate use and biosecurity was investigated and the material was found to be both nutrient-rich and free from major risks from pathogens or heavy metals. A case study showed how its use could directly replace mineral fertilizer and give economic benefit to the farmer. The project succeeded in meeting all of its objectives: contribution to EU targets and more specific impacts of the research are given in the final section.

## Concept and project objectives

The rationale for the research was that food waste arising from homes, restaurants and catering facilities, food markets and food processing activities represents a large fraction of the municipal waste stream. Actual proportions vary across the EU, but as an example in the UK food wastes that can be segregated account for around 24% of the total weight of household waste, with an approximately equal tonnage arising from industry and commercial sources. This material has a very high energy potential but is unsuited to energy generation through conventional combustion processes, as its high moisture content gives it an unfavourable lower heat value. The energy can, however, be efficiently recovered through biologically-mediated routes, provided that the process can be stabilised to deal with the high nitrogen content of these wastes. In terms of overall energy balance and carbon footprint the anaerobic digestion of food waste makes a very positive contribution to energy generation both directly, and indirectly through energy savings.

- Firstly, it provides the opportunity for highly efficient recovery of a second-generation gaseous fuel product with multiple applications for the end user.
- Secondly, it captures the nutrients present in the waste and allows these to be returned to agricultural use, with associated economic, energy and carbon gains from offsetting the requirement for artificial fertilisers.
- Thirdly, removing food waste reduces moisture content in the residual waste stream, thus improving the calorific value and the efficiency of thermal energy recovery in Energy-from-Waste (EfW) facilities, creating new opportunities for refused-derived fuel (RDF) production and increasing the range of thermal technologies that can be applied.
- Finally, by reducing the moisture and contamination levels of the remaining waste the opportunity for recovery of commodity grade recyclable materials and of the embodied energy in them is enhanced by enabling the use of advanced automated sorting technologies in materials reclamation facilities.

The key concept of the research is therefore to valorise the energy from this waste fraction by anaerobic digestion (AD), with a full evaluation of the overall life cycle energy balances associated with this process. AD is not a new technology, but its application for energy recovery in the field of municipal waste treatment is only just becoming established in Europe, and only for mixed wastes. The use of source segregated food wastes as the substrate is currently not widespread, possibly because of the technical challenges associated with collection, handling, pre-treatment and actual digestion of this material. The research comprises a number of closely interrelated components with a common underlying goal: to evaluate and where possible improve the energy production process from the perspective of the overall net energy gain achieved within defined system boundaries that include collection, sorting, processing, and beneficial use of recovered material.

### *Detailed scientific and technical objectives*

1. To evaluate the efficiency and yield of source segregated food waste collection schemes from domestic properties, restaurant and catering facilities, food markets and food manufacture.
2. To determine the energy and carbon footprint of the biowaste-to-energy process including collection, transport, treatment and final product use, considering both direct and indirect inputs. This provides the basis for a full life cycle assessment of the environmental impacts and benefits of this technology.

3. To optimise pre-treatment of the source segregated waste stream for biogas production and biosecurity of the residual product by development and trialling of novel cell disruption and autoclaving techniques.
4. To balance the digestion process using interventions to improve the carbon to nitrogen ratio for optimal volumetric biogas productivity and added value of the digestate product.
5. To gain a deeper understanding of the interaction of fundamental chemical and microbiological factors affecting the potential for energy gain from the substrate, and to convert this into practical operational protocols for stable and effective digestion of high-nitrogen wastes at loading rates that allow maximum volumetric biogas production.
6. To achieve a mass and energy balance around two full-scale digesters treating food waste, one at mesophilic and one at thermophilic temperature, which will act as a benchmark for industry in the drive for widespread implementation of the process at commercial scale.
7. To further develop low-cost small-scale biogas upgrading technologies and storage systems for application in transportation and local low-pressure distribution systems.
8. To estimate the potential for small-scale biogas upgrading in local transportation in the EU and in India.
9. To evaluate the appropriateness of scale of digestion and end-use energy conversion technologies, with particular reference to matching public and private community needs.
10. To evaluate the potential for food waste digestion as a second generation biofuel source across the EU in terms of energy yield, environmental benefit and end user requirements.

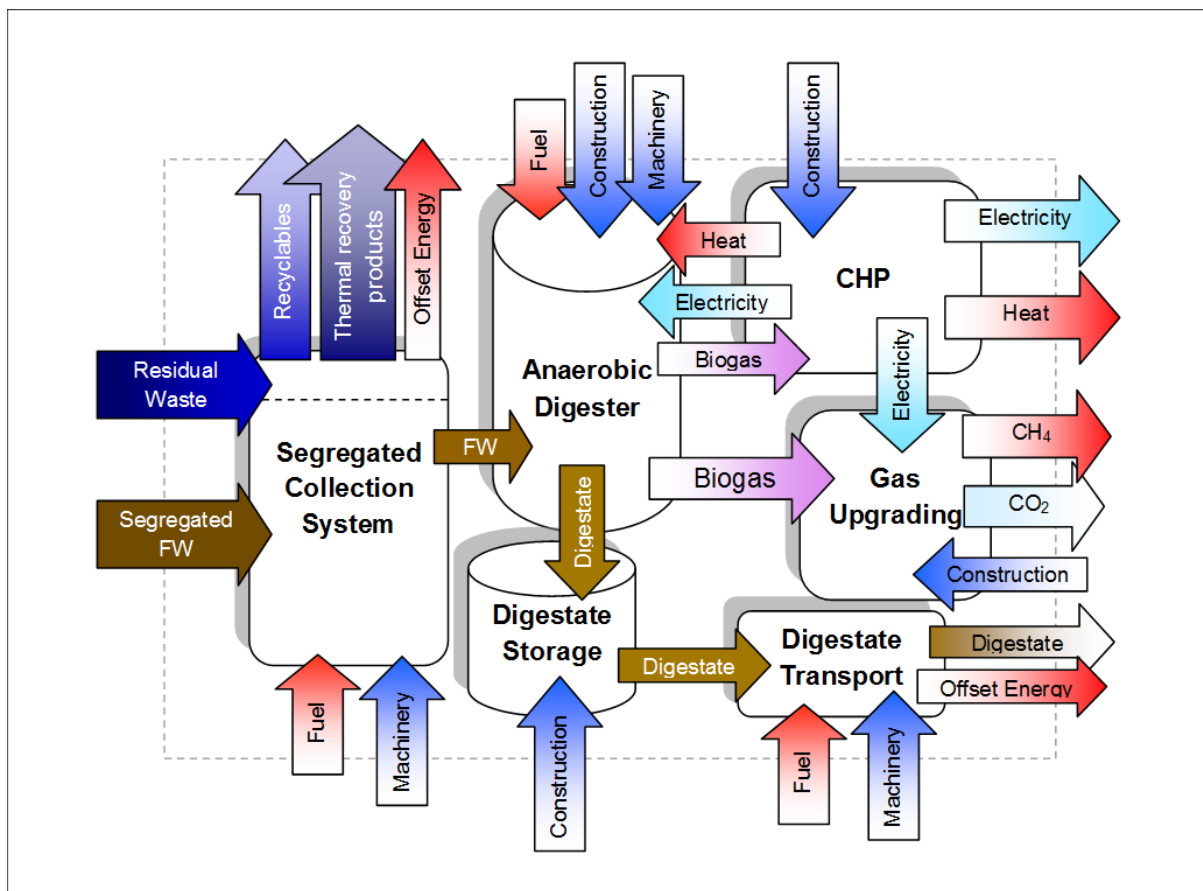

Components and system boundaries in an energy balance for food waste valorisation to biogas

### Baseline data and research indicators

The following parameters were used in verifying performance

Parameter	Baseline	Research indicators	Progress to date
Effectiveness of collection system	No baseline although performance indicators such as capture rate, level of contamination etc may be available for individual schemes.	Data on existing schemes used to assess performance in terms of yield and energy efficiency for use in overall energy balance (e.g. to identify factors producing 70% capture rate based on mass, additional energy for collection $\leq 15\%$ )	Major survey carried out to establish current status of collection in EU. Modelling and assessment methods developed and data on specific schemes in UK, Finland, Portugal analysed. Methodology established for assessment of additional energy for collection, effective systems $\leq 15\%$ . 70% capture rate rejected as an indicator as unverifiable e.g. due to reported reductions in quantities after introduction of schemes
Substrate suitability	Baseline energy value assessed by proximate analysis and calculation of lower heat value (typically $2.2 \text{ MJ kg}^{-1}$ for food waste). Energy-from-waste (EfW) electrical conversion efficiency typically 21-23%.	Net energy yield from AD $\geq 30\%$ greater than from conventional EfW and $\geq 40\%$ for electrical power.	Higher Heat Value (HHV) of substrate typically $\sim 20 \text{ MJ kg}^{-1}$ VS and Lower Heat Value (LHV) $\sim 3 \text{ MJ kg}^{-1}$ VS which on thermal conversion will provide $0.6 - 0.7 \text{ MJ kg}^{-1}$ VS. Bioconversion is achieving $15-16 \text{ MJ kg}^{-1}$ VS as methane equivalent to $5.3 - 5.7 \text{ MJ kg}^{-1}$ VS as electricity at 35% conversion efficiency. Energy from AD is thus typically $\sim 8$ times that from thermal EfW.
Performance of ammonia stripping	Typical Total Kjeldahl Nitrogen (TKN) concentration of food waste is in the range 2-3% of total solids leading to digester concentrations of $5-8000 \text{ mg kg}^{-1}$ . Typical C:N ratio	Digester operating concentration of ammonia $\leq 4000 \text{ mg l}^{-1}$ achieved by ammonia removal from either food waste substrate or digestate	Criterion of $\leq 4000 \text{ mg N l}^{-1}$ is no longer critical in mesophilic conditions due to success of TE supplementation. Gas stripping can achieve $\leq 4000 \text{ mg l}^{-1}$ .
An effective and well-functioning anaerobic process for food waste digestion (nb: feedstock dependent)	Currently digesters operating on nitrogen-rich food wastes ( $5000 \text{ mg kg}^{-1}$ wet weight) appear to suffer long-term stability problems, with elevated volatile fatty acid (VFA) concentration leading to reduced energy yield as a proportion of substrate Biochemical Methane Potential (BMP) and in the worst case process failure.	$\text{CH}_4$ yield $\geq 70\%$ of substrate BMP. Raw energy production (as $\text{CH}_4$ ) $\geq 60 \text{ MJ m}^{-3}$ reactor volume $\text{day}^{-1}$ Methane yield $\geq 75\%$ of substrate calorific value (higher heat value) Parasitic energy requirement $< 15\%$ of useable energy net yield	$\text{CH}_4$ yield from batches of food waste are typically $\geq 80\%$ of substrate BMP. Long-term semi-continuous laboratory-scale trials achieving raw energy production (as $\text{CH}_4$ ) $125 \text{ MJ m}^{-3}$ reactor volume $\text{day}^{-1}$ Methane yield $\geq 75\%$ of substrate calorific value (HHV). Parasitic energy requirements in small systems $> 15\%$ of useable energy net yield.
Mass and energy balance for full-scale food waste digester in commercial operation	No baseline values currently publicly available.	Achieve an 80% mass balance on wet weight basis over period of not less than 12 months Achieve an 80% balance on dry weight basis over period of not less than 12 months	Methodology for mass balances established and data collection at South Shropshire Biowaste Digester and Valorsul AD plant completed; 80% target achieved.

Parameter	Baseline	Research indicators	Progress to date
Biosecurity	Baseline values for digestates are defined by Commission Regulation (EC) No 208/2006.	5 log <sub>10</sub> reduction in Salmonella or Enterococcus faecalis indicators ( <i>E. coli</i> , <i>enterococaceae</i> ) <1000 cfu g <sup>-1</sup> Salmonella not detected in 25 ml digestate	Digestates in laboratory trials of autoclaved waste pass standard of <1000 cfu g <sup>-1</sup> for <i>E. coli</i> , <i>enterococaceae</i> . Some evidence of increase in Enterococcus during digestion.
Digestate stabilisation	Pilot and full-scale operational food waste digesters have reported VFA concentrations in excess of 20000 mg l <sup>-1</sup>	BMP ≤ 10% that of original feedstock  VFA concentration < 4000 mg l <sup>-1</sup>	VFA concentrations below 4000 mg l <sup>-1</sup> can now be achieved in mesophilic digesters by trace element addition, with BMP values ≤ 10% that of original feedstock. Side-stream ammonia stripping has also proved able to remove ammonia to a concentration that prevents VFA accumulation.
Gas upgrading	Baseline is dependent on the type of upgrading system used and is complicated by a trade-off between commercial costs and energy efficiency. Typical requirements in small-scale systems may be ≥10% energy content of upgraded gas (including energy consumption of ancillary processes).	Upgraded gas to meet Wobbe index LL-quality (index 34.4 – 44.8) or E (index 40.9 – 54.7)  System energy requirement ≤ 7 % energy content of upgraded gas	Trials with pilot-scale low-pressure gas upgrading equipment have achieved the target of upgrading biogas to Wobbe index LL-quality (index 34.4 – 44.8) natural gas standard. System energy requirements dependent on scale but in range 5-7%.
Effective energy generation system	No published data currently available for food waste digestion systems.	Energy Ratio (output/input) > 4	Effective overall assessment methodology developed and indicates positive energy balance and ratio > 4 for a wide range of scheme types.



VALORGAS Project partners



## Main S&T Results

### Composition and characterisation of food wastes

*Data on food waste composition was needed to underpin all aspects of the research, as this affects collection system requirements; design of digesters and pre-treatment facilities; characteristics of the final product and any special process requirements; and the overall energy potential of a scheme.*

Source segregated food waste from collection schemes in selected regions of Finland, Italy, Portugal and the UK was analysed using both compositional and physico-chemical characterisation. The aim was to gain information on the nature and properties of food waste, and on any major regional differences that could affect its behaviour as a feedstock for anaerobic digestion.

To allow comparison of results, existing systems for the classification of waste stream components were used as framework and mapped onto a single uniform system. Waste samples for compositional characterisation were obtained from 23 collection rounds in 15 cities across four EU member states. The majority of the collection schemes sampled located in the UK, to ensure the evaluation included a range of schemes specifically targeting source segregated food waste.

In addition to the compositional characterisation of the food wastes, selected samples from each of the four areas studied were analysed for parameters including: pH, total solids (TS), volatile solids (VS), total organic carbon (TOC), total Kjeldahl nitrogen (TKN), calorific value (CV), lipid, protein, total phosphorus (TP), total potassium (TK), and elemental composition (CHN).

The results showed both differences between the samples, and also an important degree of similarity. In all cases 'Fruit and vegetable waste' formed the largest portion, making up 45-70% of the total wet weight. The proportion of 'Meat and fish' was similar in all countries, and this may be important as this category is the main contributor to the high protein and nitrogen content of food waste, which leads to stability problems in anaerobic digestion. The

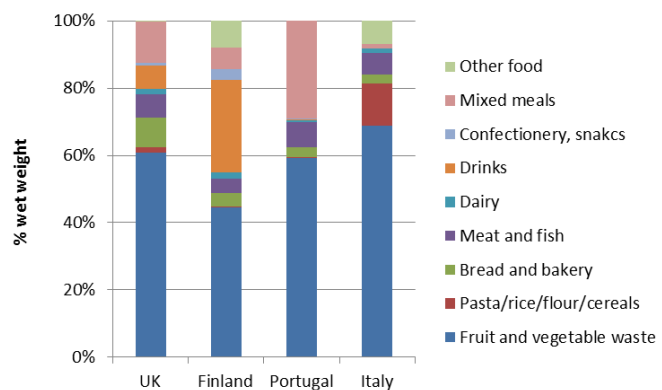

percentage of 'Bread and bakery' products was similar in Finland, Portugal and Italy and only higher in the UK; differences in this category will tend to be enhanced on a wet weight basis, as these products have a high capacity to absorb any liquid present or generated as the waste begins to degrade in transport. Only waste from Italy showed a high proportion of the category Pasta/rice/flour/cereals. 'Mixed meals' and 'Drinks' showed a particularly wide range, reflecting both national differences (e.g. ~7% tea bags in the UK, ~25% coffee in Finland) and the characteristics of the collection system (e.g. compacted or uncompacted).

Repeated sampling in the same UK locations indicated that the variation between sites is similar in scale to that between different days on the same collection round

Different degrees of contamination were found in different collection schemes. The UK samples showed low or exceptionally low contamination. The samples from Portugal and Finland had contamination levels similar to those in the UK, while the sample from Italy had a higher proportion of contaminants. These results may reflect physical and logistical aspects of the collection system (e.g. bin size, collection frequency). More speculatively, the length of time for which the system has been operating may be a factor: locations where separate collection has only recently been introduced may benefit from a sharper focus on food waste.

Biodegradable bags made up 1.6, 3.7 and 4.2% of the total sample weight for Finland, Italy and the UK respectively, and an even higher proportion with respect to the food waste component. While these percentages were for wet and dirty material, the volatile solids content of the bags themselves is very high. Fully degradable bags may therefore contribute a small but useful proportion of the overall biogas yield in anaerobic digestion, while non-biodegradable bags represent a major source of contamination, equal to about 6% of the total sample weight in Portugal, and are likely to reduce the quality of the final digestate.



Sorting food waste samples at Valorsul

In contrast to the compositional data, the physico-chemical analyses showed strong similarities between samples, especially in the key parameters for digestion. Total and volatile solids contents were very similar. TKN (organic nitrogen) was also similar and relatively high, confirming the potential for ammonia toxicity. Concentrations of plant nutrients (N, P and K) also confirmed that the digestate has significant potential for fertiliser replacement. Measured and predicted calorific values were in good agreement, and showed this is an energy-rich substrate.

Physico-chemical characterisation may be the more powerful technique in terms of assessing the suitability of a material as a feedstock for anaerobic digestion; but compositional sorting clearly provides valuable information on the degree of success in obtaining targeted materials and avoiding contamination, especially if linked with data on the type of collection system.

**Residual wastes:** Data on the composition of residual waste streams were obtained and analysed:

- England: 54 municipalities, representing 16% of the country's population
- Netherlands: 2 municipalities, representing 1.4% of the population
- Spain: 50 municipalities, representing 7% of the population (43% of the population of Catalonia)
- Sweden: 10 municipalities, representing 9% of the population
- Portugal: 1 municipality, representing 0.11% of the population

Although there were differences in analysis methodology and waste regime, the data were sufficiently consistent to allow identification of some general trends within and among the cases.

Following the introduction of food waste collections the overall mass of residual waste decreased by between 12-34% on average, depending on the country. In England, Spain and Sweden, food waste in the residual stream reduced by 26-55% leading to an increase of 9-33% in the residual net CV. The increase in calorific value for Energy-from-Waste processes varied from 0.86 GJ tonne<sup>-1</sup> residual waste in Sweden, to -0.03 GJ tonne<sup>-1</sup> residual waste (representing an energy cost) in Portugal, where the proportion of food waste in the residual after food waste collections was actually slightly higher than the pre-FWC values.

The significant portion of food waste remaining in the residual stream raises questions on the effectiveness of current collection methods. While the VALORGAS project has contributed some insights, further research is needed on reasons for the lack of effective capture, which are likely to involve the methods used, communications and community education, and the behaviour of residents and businesses in respect of their attitudes towards separate food waste collection.



## Web-based survey of food waste collections

*The collection system will influence the carbon and energy balance of the scheme, although many factors will depend on local circumstances. Before any comparison is possible it is first necessary to analyse existing schemes and identify key factors that influence their performance*

Conventional approaches of quantitative and compositional analysis for assessing the performance of source segregated food waste collection schemes are not ideal for larger-scale surveys. Experience from the project showed they were time-consuming, labour-intensive and the number of sites that could be considered was limited by the available resources. The collection systems survey needed to gather data for a representative section of Europe, where a wide range of climatic, economic and socio-demographic factors might influence performance. It was also necessary to define how performance could best be measured. For example, one significant issue with respect to the processability of food waste and the usability of the final digestate product is feedstock contamination; thus gross yield in terms of wet tonnes is not necessarily the most important parameter, unless it can be linked with detailed information on reject rates and quality of output from a downstream anaerobic digestion (AD) plant. Even measures such as capture rate may be difficult to interpret where there is little baseline data to allow valid comparisons between schemes.

During the planning stage of VALORGAS it became clear that, apart from some broader studies, there was relatively little data specifically relating to FW collections in different EU member states, or even agreement on a definition of what constitutes 'separate' collection. It was therefore decided to carry out a web-based survey of each of the 27 EU member states, with the aims of identifying trends and models in source segregated FW collection, and of assessing whether these are likely to have an impact on the effective valorisation of this material.

The survey technique developed used two main methods: firstly, visiting the websites of all or a proportion of the organisations responsible for waste management; and secondly using search terms related to segregated collections and food waste. The first pilot trial was run in England and adopted the exhaustive approach, visiting the webpages of each of the 325 local authorities responsible for waste collection. This proved effective, but in the case of some EU countries was impractical. In both Spain and Italy, for example, there are over 8,000 municipalities and even a 15-minute search of each website would require over a year to complete a country survey. In these cases a structured approach was adopted, with an overview at regional level followed by drilling down in more detail in certain areas. In Spain particular attention was given to the north where FW collections are more widespread. In Italy a systematic search was carried out of the webpages of all 516 municipalities with more than 20,000 inhabitants; this included a further 270 associated municipalities, and covered over 55% of the population. In Germany websites for all 401 districts in 15 federal states were searched to determine whether FW collections existed, then collection practices in the 96 districts in one state (Bavaria) were considered in detail.

There were clear methodological issues in the survey methods used. Even in Europe, web access is more widespread in some countries than others. A web survey that shows an absence of information on local collections may therefore indicate that this is not the method of dissemination used, rather than that such collections do not exist. In addition the sources of supporting data used were different in different countries, and even with a single country might refer to different years. Source segregated collection is developing rapidly, and information thus goes out of date very quickly. The results are therefore not directly comparable between countries, and have been treated with great caution in quantitative terms. The aim of the survey, however, was not to produce a definitive picture of the status of collections in the EU, but to provide a snapshot of approaches used and of information currently available to the public on the operation of these schemes.

From the results, it was evident there are strong common elements between schemes in different countries, but also major differences even within countries; and as yet there is no single accepted collection method. A variety of models were identified, ranging from those that specifically collect mixed FW and garden waste in large containers to those targeting FW only, often using small kitchen caddies and lockable bins. Many schemes accept household biowastes, but in practice the main component may be food waste e.g. from collection rounds in urban areas where properties do not have gardens. Others may also accept small quantities of kitchen paper products etc although the major fraction is food waste (e.g. in Finland, Netherlands, Slovenia).

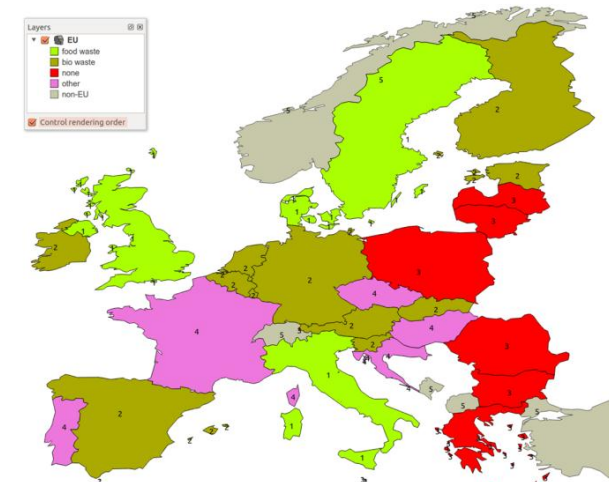

Distribution of FW collection types

This information is important, as the type and quality of materials delivered to the treatment plant may have significant consequences for the complexity of pre-treatment operations, the performance of the digestion process, the quality of the digestate product, and the net energy production of the scheme as a whole: observations supported by mass and energy balances for the Valorsul AD plant and the South Shropshire Biowaste digester. In general the use of small containers (e.g. a 5-7 litre kitchen caddy plus a ~20 litre external bin) makes it difficult to use them for disposal of other types of waste. The more complex process flowsheets of many European AD plants which receive mixed biowaste are possibly a consequence of the higher levels of contamination associated with the type of collection scheme used. It is clear however that extremely low levels of contamination are usually associated with FW-only collection schemes.

The survey also noted that definitions of acceptable and unacceptable materials are frequently inconsistent between different municipalities and waste management authorities, even within the same country and region: the only exception to this was the Netherlands, where central government provides a single nationwide definition. Biodegradable plastic bags provide an important example of this, with no consistency between neighbouring schemes and unclear or even contradictory information given to the public. This is especially important in view of findings elsewhere in the VALORGAS project that, in collection schemes with apparently high proportions of contamination, a very significant fraction of this is made up of non-biodegradable plastic bags.

### Modelling of waste collections

*The type of collection scheme can have a large impact on downstream processing and product utilisation. Source segregation of targeted food waste streams reduces these impacts but potentially at the expense of more intensive use of energy and resources. There was thus a requirement to develop tools to allow optimisation of these for dedicated collection systems.*

Comparison of options for food waste collection was a key component of the VALORGAS project, both as a task in its own right and to provide data for the overall energy balance assessment. Case studies were carried out on a number of collection schemes across Europe showed there was a general shortage of reliable data. Where this is accessible, it is often inconsistent in format or only covers very short periods: but often it simply does not exist. As one municipality in Denmark remarked, "We don't collect this data because it is of no use to us - but of course, it cannot be useful to us, because we don't collect it!".

Even where information is available, the performance and efficiency of a collection scheme is affected by many parameters that cannot necessarily be optimised. These include factors like climate and population density which are outside the control of the operator, as well as those that can be controlled or influenced, such as collection frequency and participation rate. It is clear, for example, that the distance travelled and the amount of fuel needed to collect a tonne of food waste in a sparsely populated area will be more than in the centre of a big city; but this does not necessarily mean the rural scheme is badly run or ineffective.

To address these issues and create a rigorous and consistent basis for comparing collection options, a modelling approach was adopted. Methods based on life cycle assessment were trialled, but were both data hungry and strongly affected by initial assumptions, especially those concerning system boundaries. It was concluded that full LCA is not yet a suitable method for selection of collection systems in a practical industry context.

The research therefore focused on deterministic modelling of energy and GHG emissions for different types of collection, as these parameters are quantifiable and provide key data for other activities, including LCA and economic assessment. A mechanistic model was developed, based on approaches used by Sonneson (1997) and Everett and Shahi (2004) but taking these forward to include the service time and the volume and load capacity of the collection vehicles.

The model was validated using data gathered from real collection schemes: these included two rural, two suburban and two high-density inner city areas. Validation sites were chosen from within the UK, to minimise other sources of variation: but the project also gathered data in other EU countries, and this will be further explored during the post-completion exploitation phase. A major strength of the model is its ability to optimise co-collection of food and residual or recyclable wastes in twin and multi-compartment vehicles. A hypothetical case study was carried out of a city 20,000 households under a range of common collection scenarios. The results not only indicated which options were most efficient in terms of energy use, but also provided other insights, for example showing that in twin vehicles a 70:30 compartment split is always more efficient than 50:50. Differences in fuel consumption for the same level of service could be 25% or more. In some cases, however, an energy-efficient scheme may have a greater requirement for staff time: from an economic viewpoint either of these parameters may be critical, depending on the relative costs of labour and fuel in a given country.

To facilitate rapid comparison between multiple scenarios the model was coded as a piece of software: it now provides an immensely powerful and flexible tool for comparative assessment. The

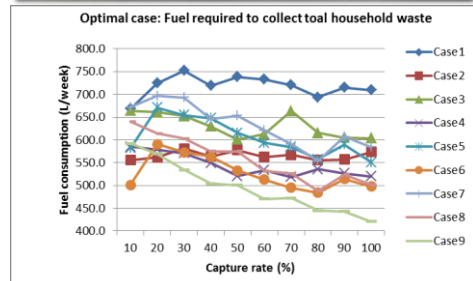

Waste Collection Assessment Tool (WasteCAT) can be used to model alternative options for new collection schemes; or to benchmark the performance of an existing scheme against modelled output. Rather than identifying a single optimum solution, it provides a decision support tool for planners and operators to investigate the consequences of their decisions: in reality a wide range of parameters will influence choices made. It does, however, offer a robust basis for comparison of options and a powerful research tool for investigating the impacts of collection systems.

The WasteCAT model was primarily constructed for the purpose of evaluating energy consumption. Results from modelling were used to deduce 'typical' energy costs per tonne of food waste collected, as a component in the overall energy balance for food waste valorisation to biogas. Outputs include energy (fuel) consumption and staff time (contributing to running costs, and to GHG emissions in the case of fuel), and vehicle numbers (an indicator of capital cost and embodied energy). The model already allows user-specified vehicles: in future it is hoped to include a wider choice of non-conventional vehicle and fuel types.

The current version of WasteCAT is available from [www.valorgas.soton.ac.uk](http://www.valorgas.soton.ac.uk). Version 2, which includes a sensitivity analysis option, will be released after beta-testing.

### **Appropriate scales for AD in public and private communities**

Case studies were carried out to determine food waste generation rates and assess appropriate scales for on-site AD in a range of public and private communities. These included a hospital, prison, a number of army sites, a small-scale community AD plant, the Port of Dover, the town of Stratford upon Avon, the county of Somerset and a Veolia depot, as well as three partner universities (University of Southampton, IIT Delhi and Jyväskylä University). A theoretical case study was also carried out on the effects of scale in point and dispersed sources of food waste.

The studies ranged from the very small (15 m<sup>3</sup>, 68 tonnes year<sup>-1</sup> at Harrogate District Hospital) to large commercial scale (~4700 m<sup>3</sup>, 21000 tonnes year<sup>-1</sup> for the county of Somerset). As expected, the smallest systems would make only a minimal contribution to the overall energy consumption of the institution concerned, and are unlikely to be constructed for economic reasons (e.g. Harrogate District Hospital; Welbeck College). In this situation the best solution may be to join a local or municipal food waste collection scheme, where one is available. In some cases, however, adoption of anaerobic digestion may be favoured due to associated social or environmental benefits (e.g. HMP Hewell); this is especially so if the organisation has the capacity to construct and operate the plant in house. Larger institutions such as universities are equivalent in size to a small town, and on-site AD can be feasible especially if it uses existing infrastructure such as CHP plants. A study of collections from hospitality sector businesses provided an example of commercial considerations favouring the introduction of a scheme which is not initially energy-efficient, but where major improvements can be achieved. Once the community to be served is the size of a county, AD becomes a practical option and location and routing of collections are the predominant issues. The theoretical study provided a means of assessing overall energy inputs and outputs from point source and distributed populations, as well as indicating their sensitivity to different factors and assumptions in planning the scheme. The results do not represent a complete energy balance, since embodied energy and materials were not included: but the approach provides a means of energy budgeting to determine the feasibility of a scheme and its pay-back period in energy terms.

To extend the range of scales at which AD is viable there is clearly a need to develop smaller, cheaper, modular digestion systems, and at or near-market examples of these are beginning to appear, as shown in the Evergreen Gas case study. Larger scales still present problems, however: despite proximity to feedstock supplies and energy demands, construction of AD plants in urban areas is often problematic due to high costs, public objections, lack of space for digesters and digestate, and increased traffic from transport of feedstock and digestate. Conversely, large out-of-



town AD plants may conflict with the 'Reduce' element in the waste hierarchy, as the profitability of these units is eroded or eliminated when waste quantities reduce or unit transport costs increase.

One approach proposed to address this is the creation of networks of small-scale AD plants, bringing a wider range of benefits than is captured by economic and energy balances alone. The concept of an urban micro-AD network has been put forward by the Local Energy AD-venture Partnership (LEAP), and offers coordination between sites as well as shared learning and best practice, thus enabling more rapid development of expertise. A network can also buffer individual system downtime, as other sites may temporarily accommodate extra feedstock. The range of participating sites can span the education, business and community sectors, demonstrating the versatility of the technology. In the final part of this work the case study methodologies and other materials from the VALORGAS project were used to support the development of this approach, with a view to further implementation and evaluation in Horizon 2020.



*Very small-scale digesters for single businesses are now entering the market*

### **Food waste and ammonia toxicity to digestion**

As already noted, although food waste generated in homes has a high moisture content its high energy potential could be recovered by anaerobic digestion. The high protein content of the material, however, gives an unfavourable carbon to nitrogen ratio for the digestion process: this can result in accumulation of ammonia in the digester, which is known to be inhibitory to the process. To overcome this potential limitation the VALORGAS project proposed two solutions:

- To reduce the inhibitory effect of ammonia by manipulation of the process microbiology
- To actively remove nitrogen from the process stream by physical or chemical means

#### ***Manipulation of process microbiology***

Before the start of the VALORGAS project, several food waste AD plants had shown accumulation of volatile fatty acids (VFA) after months of successful operation. Research into this, funded by the UK government, led to some observations and clues as to why long-term instability could occur with this feedstock (Banks and Zhang, 2010). As a result of this work it had been postulated that non-reversible accumulation of propionic acid occurred because of a deficiency of the trace elements required for synthesis of the enzymes used in syntrophic hydrogenotrophic methane production. In particular selenium (Se), molybdenum (Mo) and tungsten (W) had been identified as possibly critical because of their importance in the formate dehydrogenase enzyme. A metabolic block at this stage could cause accumulation of formate, triggering a feedback inhibition in propionic acid oxidation. Selenium had been found to be present only at very low concentrations in source segregated domestic food waste collected in the UK; and although these trace elements are typically present in inoculum taken digesters treating municipal wastewater biosolids, over a period of time they will be diluted out of an operational food waste digester. The potential importance of selenium in anaerobic digestion plants had not been documented at this time, although some pure culture studies with methanogens had indicated its importance in some enzyme systems.

#### ***Trace element supplementation in mesophilic food waste digesters***

The VALORGAS project tested the requirement for trace elements, including selenium, of food waste digesters operating at mesophilic and thermophilic temperatures in long-term semi-continuous fed digestion trials. These trials were used to:

- Confirm that long term stability of the process could be achieved



- Establish the maximum operational loading and volumetric methane productivity
- Understand the process microbiology and biochemistry
- Demonstrate stable operation at a large scale.

Earlier studies using a factorial design batch testing system had indicated that both Se and Co could stimulate the removal of accumulated VFA: the VALORGAS project focussed on digesters running in continuous mode over with daily feeding. Over the 42-month project period a set of 12 digesters at Soton were used to test operational parameters under mesophilic conditions and a further 8 to investigate the process microbiology and the potential for thermophilic operation.



Continuously operated lab-scale digesters at Soton

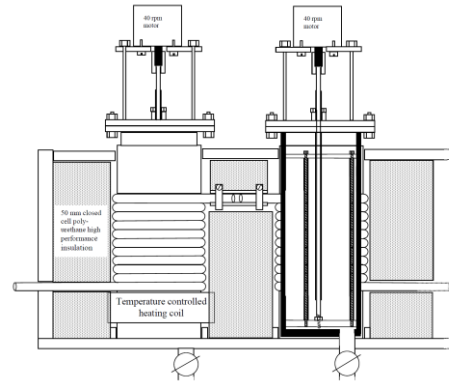

Details of laboratory scale digesters

Digesters were also run for more limited periods to establish the threshold limits for operation with respect to ammonia. The digesters used were of a standard continuously-stirred tank reactor (CSTR) design. The first long-term trial used a number of trace element supplements, but the main finding was a clear demonstration of the need for Se at all loadings and for Co as the loading increased. At the end of the first year digesters were successfully operating at a process loading of  $5 \text{ kg VS m}^{-3} \text{ day}^{-1}$  despite an ammonia concentration of around  $5.4 \text{ g N l}^{-1}$ , with a volumetric methane production of  $2.2 \text{ m}^3 \text{ CH}_4 \text{ m}^{-3} \text{ day}^{-1}$  and a specific methane production of  $0.43 \text{ m}^3 \text{ CH}_4 \text{ kg}^{-1} \text{ VS}$ . It was estimated that the minimum concentrations for Se and Co in the digester were around  $0.16$  and  $0.22 \text{ mg l}^{-1}$  respectively at a moderate organic loading rate. It was also established that a total selenium concentration greater than  $1.5 \text{ mg l}^{-1}$  was likely to be toxic to the microbial consortium.

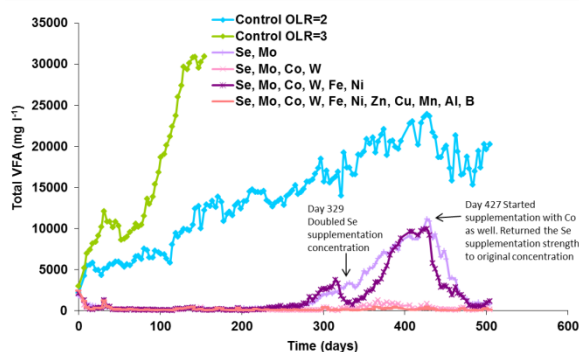

Summary graph showing stable operation with Se, and requirement for Co at higher loadings

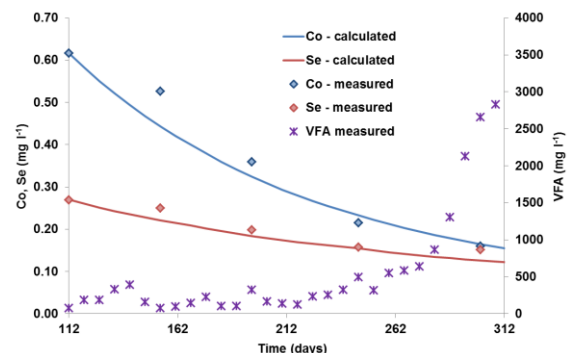

Dilute-out curve used to estimate critical concentrations of Se and Co

Analysis of the digester population structure was possible using a differential centrifugation clean-up procedure that allowed the bacteria and archaea to be separated from waste biomass. When

analysed using FISH techniques, the methanogenic population in high ammonia food waste digesters comprised only hydrogenotrophic methanogens: this was later confirmed using a  $^{14}\text{C}$  radio-labelled acetate tracer technique. The transition in methanogenic population was followed using FISH analysis in a second set of digesters: this revealed changes in the predominant methanogenic family from *Methanosaetaceae*, which are known to utilise the acetoclastic metabolic pathway and are the dominant group in digestate from sewage sludge, with a rapid succession to *Methanosarcinaceae* becoming dominant and then being replaced by *Methanomicrobiales*. Although there was no direct evidence linking this to digester ammonia concentration it is interesting to note that the first transition took place at a total ammonia nitrogen (TAN) concentration of  $\sim 2500 \text{ mg N l}^{-1}$  and the second when the TAN concentration reached  $\sim 4000 \text{ mg l}^{-1}$  which is the range where digester instability becomes apparent without Co and Se supplementation.

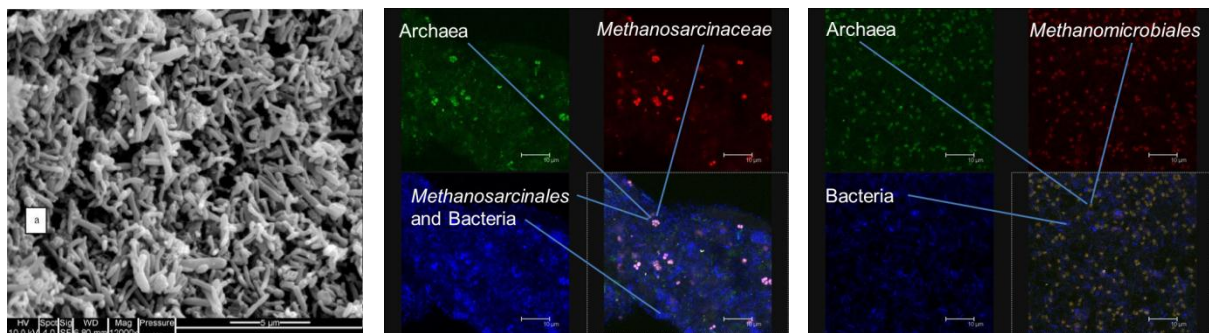

Bacteria and archaea after FISH analysis from a low ammonia digester  
 FISH analysis from a low ammonia digester  
 FISH analysis from a high ammonia digester

Work at this scale continued into the second and third years of the project with a number of experiments designed to test the limits and robustness of the trace element supplemented food waste digesters. In total this set of digesters ran for over 1200 days. During this time the loading was successfully increased to stable operation at  $8 \text{ kg VS m}^3 \text{ day}^{-1}$ : at the time of reporting the digesters were operating at  $9 \text{ kg VS m}^3 \text{ day}^{-1}$  but had not yet reached a reportable steady state condition. At the highest loading there was some reduction in the specific methane yield compared to control digesters, but this was marginal at  $\sim 0.01 \text{ m}^3 \text{ CH}_4 \text{ kg}^{-1} \text{ VS}$  (around 2%). The average specific methane yield was  $0.46 \text{ m}^3 \text{ CH}_4 \text{ kg}^{-1} \text{ VS}$  and the volumetric methane production was  $3.5 \text{ m}^3 \text{ CH}_4 \text{ m}^3 \text{ day}^{-1}$ . These values represent a more than four-fold increase in the organic loading rate with an equivalent increase in methane productivity. The impact is that digesters treating food waste could be built at one quarter of the size, or treat 4 times as much material as was thought possible at the beginning of the VALORGAS project. The work has not shown any trace elements other than Se and Co to be deficient in food waste digesters operating at up to  $5 \text{ kg VS m}^3 \text{ day}^{-1}$ , and for this reason the planned large-scale trial was carried out only using Se and Co supplementation.

The results of the technical-scale trial clearly showed trace element supplementation was effective at reducing the VFA concentration and allowing stable operation at the design loading of  $5 \text{ kg VS m}^3 \text{ day}^{-1}$ , but logistical issues with food waste supplies meant that higher loadings were not attempted at this scale.

Work to establish the limiting concentration of ammonia even with trace element supplementation was carried out using food waste supplemented with urea. This allowed the ammonia concentration to be raised above the  $5\text{-}6 \text{ g N l}^{-1}$  commonly found in food waste digesters. Ammonia was found to be strongly inhibiting to the hydrogenotrophic methanogens at concentrations around  $8 \text{ g N l}^{-1}$ .

The requirement for trace elements was also demonstrated in other work carried out as part of the programme but not directly targeted for this purpose. Where trace elements were not added to control digesters in a trial to test autoclaved food waste the digesters failed; in a second trial of this

type VFA concentrations reduced when trace elements were added, and in the pilot-scale trial comparing autoclaved and unautoclaved waste Co, Se and Ni supplements were therefore used to ensure stable operation was achieved.



Technical scale demonstration of Se and Co supplementation to control digester stability

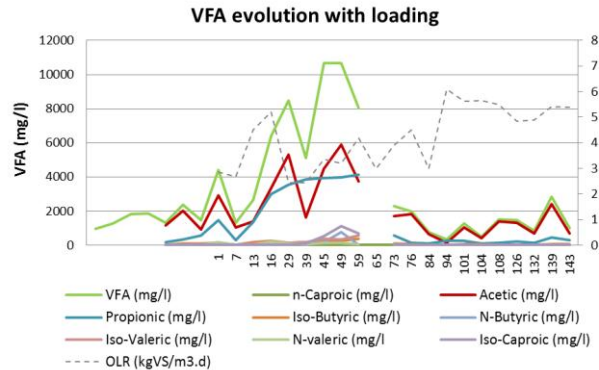

Reduction in VFA after adding Se and Co on day 51

### Trace element supplementation in thermophilic food waste digesters

Two attempts were made at Soton to acclimate a mesophilic digestate to thermophilic conditions and then to further acclimate this to food waste. Although acclimatisation to thermophilic conditions was relatively straightforward it was not possible to prevent, by trace element addition, VFA accumulation in thermophilic conditions. The same result was shown in experiments at UNIVR using trace element supplemented and unsupplemented laboratory-scale food waste digesters.

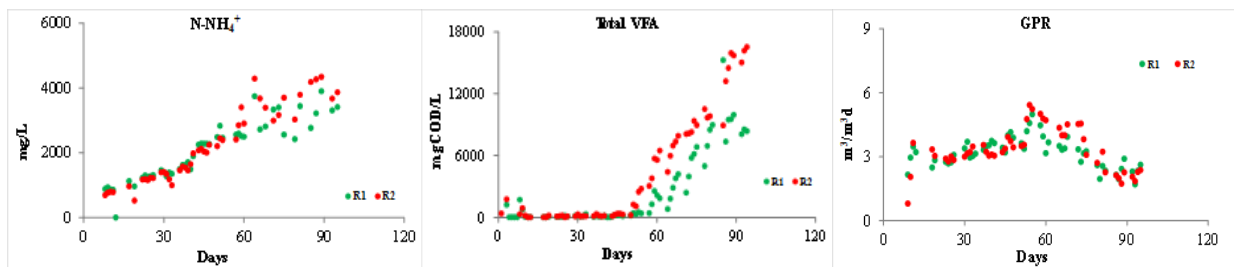

Influence of increasing ammonia on VFA and biogas production in thermophilic food waste digestion

The inhibitory threshold concentration of total ammonia nitrogen was between 2.5 and 3.5 g N l<sup>-1</sup> and this could not be raised by adding supplements as had been the case in mesophilic digesters. The work at both Soton and UNIVR did, however, show that trace element addition to thermophilic digesters could delay the onset of the symptoms of digestion failure, probably by raising the critical threshold slightly; but this improvement is insufficient to sustain long term digestion against a rising TAN concentration.

The critical threshold TAN concentration was confirmed using two approaches: firstly by supplementing a synthetic low nitrogen food waste with urea to allow operation of pairs of digesters both above and below these limit values; and secondly using water to dilute the ammonia concentration in the food waste feedstock (see below) Both techniques gave the same result. The methanogenic community structure in the thermophilic digester fed with normal food waste, as assayed using FISH, also changed during the acclimatisation phase. After around 120 days of operation, when the TAN concentration rose above 4000 mg N l<sup>-1</sup> and total VFA concentrations reached 15000 mg l<sup>-1</sup>, it became difficult to detect fluorescence emission during microscopic observation of samples from these digesters. This could indicate that the activity of methanogens as a whole was very low at that stage and the density of ribosomal RNA did not reach the threshold

level for strong fluorescence emission for light microscopic observation. Conventional FISH analysis was not therefore ideal for detecting the presence or absence of specific groups of methanogens under these circumstances.

## Active removal of nitrogen from the process stream by physical or chemical means

### Ammonia stripping

During the first year of the project a model based on preliminary experimental work was developed to look at different scenarios for ammonia removal into the gas phase. The model and experimental results all indicated that to achieve ammonia removal by gas stripping would require both high temperature and high pH. A number of alternatives were considered but modelling suggested that both in-situ ammonia removal from the digestion tank in conjunction with gas mixing and side-stream stripping were possible options. Both these approaches could reduce the TAN concentration to < 50% of the predicted value without stripping, and below the inhibitory threshold for both mesophilic and thermophilic digestion systems (with or without TE supplementation). In-situ ammonia gas stripping was carried out in the second year using 75-litre reactors containing a synthetic digestate at a TAN concentration of  $5 \text{ g N l}^{-1}$ . Tests were carried out under mesophilic and thermophilic conditions and at different gas recirculation rates. It was concluded that under both conditions the gas flow rates required were substantially higher than those needed for mixing and, after consultation with SME partners, were considered to be unrealistic in a full-scale system. Attention then focussed on the side-stream process, after further lab-scale trials using fresh digestate provided more modelling data which confirmed this as a feasible approach from a physico-chemical prospective. The major unknown was if the high temperature and pH to which the biomass would be exposed in the side-stream process would be detrimental to digestion. Experimental work in the third year therefore used this approach at a small pilot-scale in a continuous trial where each side-stream stripping column was linked to and operated with a mesophilic food waste digester.

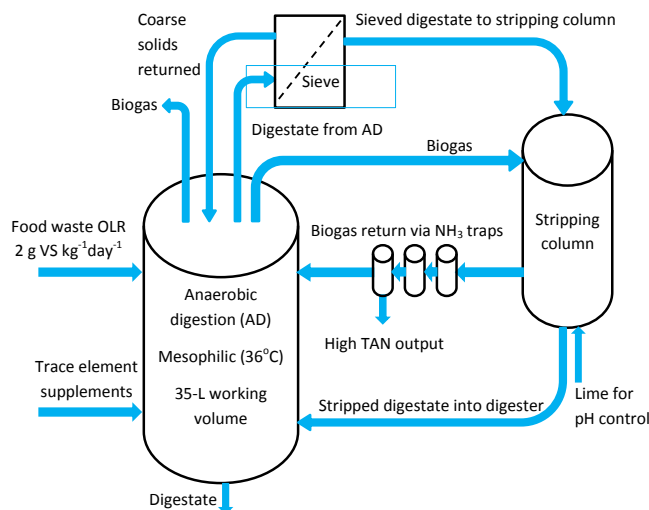

Diagram of coupled ammonia stripping and digestion plant



35-litre digesters and stripping columns

All four digesters used were run with the same feedstock, temperature ( $36 \pm 1^\circ\text{C}$ ) and at the same organic loading rate irrespective of the operating conditions of the side-stream stripping process. A number of different stripping temperatures ( $55$ ,  $70$  and  $85^\circ\text{C}$ ) were used in addition to pH control in some of the stripping tests. Where the pH in the stripping column was adjusted, this was done by adding lime at  $18.6 - 21.4 \text{ g CaO kg}^{-1}$  digestate (wet weight) to obtain a pH value around 10.



The performance and stability of the digesters did not appear to be affected by any of the measures introduced in the stripping columns. Specific biogas production remained stable at  $\sim 0.84 \text{ m}^3 \text{ kg}^{-1} \text{ VS}$  with a methane content  $\sim 58 \%$ , and VFA concentrations remained below  $400 \text{ mg l}^{-1}$ . To achieve a TAN concentration  $\leq 2.5 \text{ g N l}^{-1}$  (necessary for thermophilic digestion) a side-stream stripping process using both high temperature and pH adjustment was necessary and operation at pH10 and a temperature  $\geq 70^\circ\text{C}$  is ideal, making the process more suited to thermophilic conditions. An interesting finding was that the high temperature alkaline conditions in the stripping process improve hydrolysis of the input waste material, leading to a slightly higher biogas production and lower digestate TKN.

### **Evaporation**

The feasibility of ammonia removal from the recirculated digestate of a two-phase food waste thermophilic AD process was tested at pilot scale using a vacuum heat pump evaporator. The efficiency of the process depended on contact time but it was found to be an effective means of preventing ammonia build up in a two-phase process for Hythane production (see below).

### **Precipitation**

The feasibility of precipitating nutrients from separated digestate was investigated in the early part of the project. This approach is often considered for the recovery of nutrients as high added value products, but it is also a potentially valuable means of recovering recirculation water that is low in nitrogen from the process. Low N water can then be used to dilute the incoming food waste and consequently reduce the TAN operating concentration in the digester. Although struvite precipitation was shown to be feasible, the molar ratio requirement for magnesium was very high when magnesium oxide was added as the magnesium source. The performance could, however, be optimised using magnesium chloride to remove and recover more than  $\sim 80\%$  of the nutrients at the minimum molar ratio. The major problem with this approach, however, is the increased chloride content in the effluent flow and the further impact this would have on digester operation if used in a high ratio recirculation. An additional difficulty is the energy and equipment costs associated with operating large-scale continuous centrifuges to carry out the required solids/liquid separation.

### **Autoclaving**

One interesting and unexpected anomaly that arose during the VALORGAS project was the unexpected reduction in digester TAN concentration as a result of the heat pre-treatment of the food waste using an autoclave. Autoclave pre-treatment was included as part of the project as its use would improve the biosecurity of the process and its digestate product, with the further potential advantage of increasing the biogas yield by thermal hydrolysis of more recalcitrant elements in the waste stream. Autoclaved and unautoclaved feedstocks derived from a single batch of food waste were tested in a long-term trial at MTT over a period of 569 days. The autoclaved waste gave a consistently lower specific methane yield in the continuous trial over a range of loadings from 2 to 6  $\text{kg VS m}^3 \text{ day}^{-1}$ . The biochemical methane potential (BMP) of autoclaved waste was also lower than that of unautoclaved material. Tests to quantify the residual methane potential of digestate from the digester fed on autoclaved waste showed a lower methane potential compared to that fed on unautoclaved waste. This, together with the lower ammonia release, provided evidence that the autoclaving process led to a denaturing of proteins making them recalcitrant to further breakdown. The biogas was also found to have a much lower hydrogen sulphide content, indicating that sulphur is also locked up, again probably in the form of denatured protein.

Smaller scale laboratory work was also carried out by Aerothermal on autoclaved food waste that had been treated at different temperatures, compared to unautoclaved material. This trial was designed to test whether the autoclaved material with its lower TAN potential could be digested at high organic loading rates without the need for trace element supplementation. The work confirmed



other studies in showing that food waste digestion without trace elements will result in VFA accumulation and process failure. When using the autoclaved waste the lower ammonia concentrations in the digester were below the critical threshold toxicity concentration for methanogens, and the digestion process was successfully tested to a loading of  $7 \text{ kg VS m}^{-3} \text{ d}^{-1}$  without trace element supplementation. Some reduction in methane yield was still observed, however, again probably due to thermal denaturing reducing the biodegradability of proteins. The work concluded that if autoclaving was to be used as a pretreatment to the AD process the optimum is  $140^\circ\text{C}$  and higher temperatures could result in the formation of inhibitory compounds.



11-litre digesters used for autoclaved food waste digestion

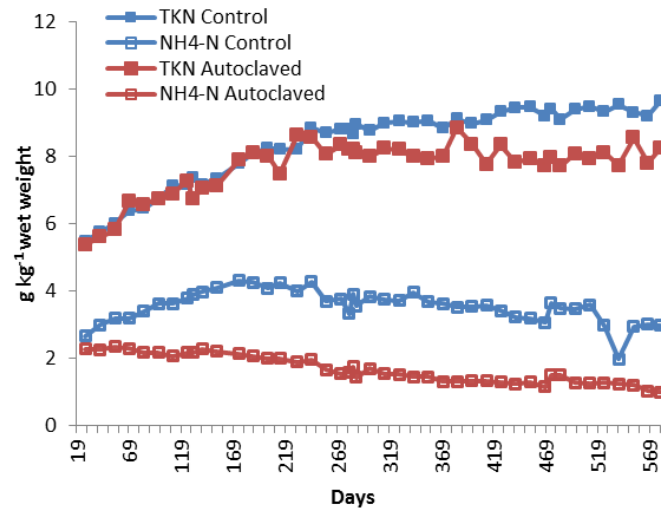

Variation in TKN and ammonia between digester fed on autoclaved and un-autoclaved food waste

Autoclave pre-treatment was also tested in a technical-scale trial carried out by Greenfinch and Aerothermal to assess any potential differences due to scale and to variability in waste, which was collected and processed over a period of 11 months from July 2012 to June 2013. Two 1000-litre digesters were used, one running on autoclaved feedstock, the other an untreated control. The digesters were seeded with digestate from a commercial plant treating food waste and acclimated for a period of 7 months before the comparative study started. Food waste was collected from the same source (Eco Sustainable Solutions Ltd) and half of each load was autoclaved in a 350 kg capacity autoclave with a double helix feed, mixing and withdrawal system. The autoclave operated at a temperature of  $160^\circ\text{C}$  with a hold time of 45 minutes. Both autoclaved and unautoclaved waste was then macerated by passing through a IMC shredder before being fed to the digester. Both digesters received trace element supplementation.

The trial showed that the autoclaved food waste gave a slightly reduced specific methane yield at an organic loading rate of  $4 \text{ kg VS m}^3 \text{ day}^{-1}$ . Analysis of the digestate again revealed a significantly lower total ammonia nitrogen (TAN) concentration which was generally  $< 4 \text{ g N l}^{-1}$  in the digester treating autoclaved waste compared to values as high as  $7 \text{ g N l}^{-1}$  in the digester receiving unautoclaved material. The digester treating autoclaved material also had a lower pH, a reduced  $\text{H}_2\text{S}$  concentration in the biogas, and was less likely to show variability in VFA concentration. Autoclaving was also found to be an effective method of decreasing the pathogen content within the digester.

A mass balance of the nitrogen components suggested that if the non-converted TKN was in the form of proteins, the methane potential of these would be sufficient to explain the missing specific methane production from the autoclaved waste. The large-scale trial therefore confirmed the results that had been observed in both laboratory trials and added further evidence to support the theory that the lost gas production was due to protein denaturing.



Autoclave used for food waste preparation



Technical scale plant used in autoclave digestion trial

### Process modifications to improve methane yield or biogas composition

The VALORGAS project included the testing of two specific pre-treatments both offering the potential for improved biosecurity and an enhanced specific methane yield by making the biomass feedstock more amenable to biodegradation. These were autoclaving and 'cellruptor' technology

It was also proposed that a more valuable energy product could be obtained by combining methane and hydrogen production in a two-phase process to produce hythane as a final product. In addition thermophilic digestion of food waste could be an attractive option, as digestion at a higher temperature could offer process advantages due to increased rates of reaction and the potential for high process loadings. It could also present some challenges as had been seen at an earlier date in at the full-scale AD plant operated by partner Valorsul.

#### **Autoclaving**

As noted above, the use of autoclaving as a pre-treatment to improve specific methane yield was unsuccessful and methane production was in fact slightly reduced. The process did, however, show some exploitable findings as the nitrogen remained locked up in an organic form making it less volatile in downstream applications. Sulphur was similarly locked up reducing both the formation of hydrogen sulphide, which is an unwelcome component in biogas, and the production of soluble sulphides which are inhibitory to the digestion process and can also precipitate out essential elements. The process thus shows promise for high protein materials where the ammonia content may exceed toxicity thresholds, especially in thermophilic conditions and where there are biosecurity issues (e.g. slaughterhouse wastes). These potential exploitable advantages will now be explored in depth by the appropriate partners.

#### **Cellruptor technology**

Extensive work was carried out by MTT to evaluate the claims made by Ecosolids International for their patented technology based on CO<sub>2</sub> pressurisation and rapid depressurisation. In the end it was concluded that the technology could not be used to improve the specific methane yield from the digestion of food waste, nor was it an effective sanitising technique when used with anaerobic digestate from food waste. Work on this technology ceased in year 2 and was not taken forward to technical-scale trials.

#### **Hythane production in a two-phase process**

Initial pilot-scale trials in the first year of the project indicated a high yield of hydrogen could be obtained from food waste, but this was difficult to maintain in a stable state when run in continuous mode. This was due to the establishment of methanogens in the first phase hydrogen-producing reactor and the increase in ammonia due to cell and liquor recycle. The use of an ammonia

evaporation unit to treat the return flow between the two phases was trialed in the second year of the project to solve this problem. This allowed the ammonia concentration to be maintained at around  $500 \text{ mg N l}^{-1}$ , then hydrogen production could be maintained by selecting the appropriate recycle ratio to provide ideal pH conditions in the first-phase reactor. Productivities were not as high as previously been observed and VFA did accumulate as secondary products. Further optimisation is required to ensure stable hydrogen production can be achieved over longer periods of time.

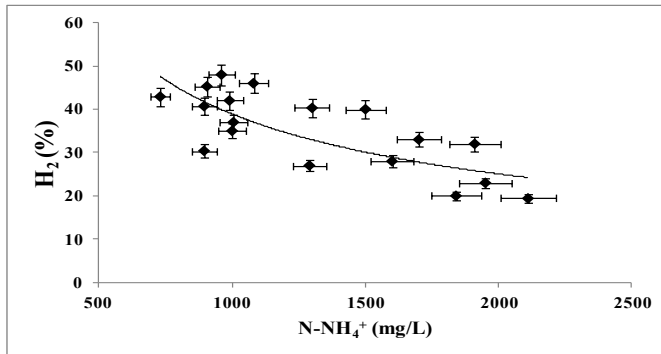

The effect of ammonia on biohydrogen production



Ammonia evaporator used in two-phase hythane production process

### Thermophilic digestion

As reported in the preceding sections, thermophilic digestion of food waste at a natural retention time was not possible as the ammonia concentration increases above the critical inhibitory threshold and process failure is thought to be inevitable at a TAN concentration above  $3.5 \text{ g N l}^{-1}$ . A number of possible solutions to this have been proposed, all of which have energy and/or resource implications. The large-scale anaerobic food waste digestion plant operated by Valorsul in Lisbon operates at a thermophilic temperature, and process ammonia and VFA concentrations are kept within the limits of tolerance by dilution with wastewater from the plant after treatment by aerobic biological treatment and ultrafiltration. Dilution is thus a possible mechanism for operation of thermophilic digestion plant.

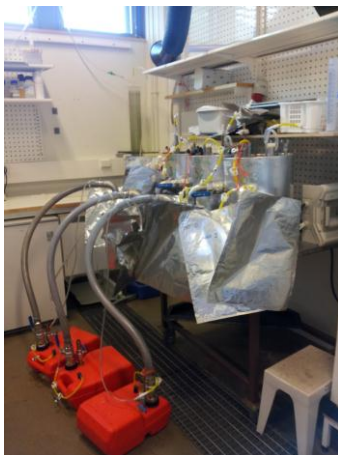

Thermophilic digesters used in dilution trials

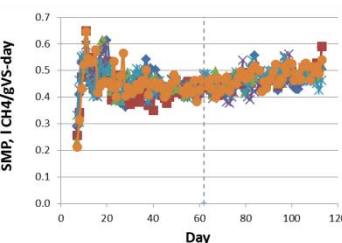
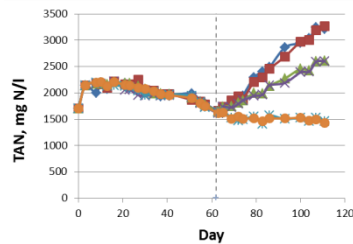

TAN and specific CH<sub>4</sub> production in digesters at no, 1:1 and 1:2 dilution

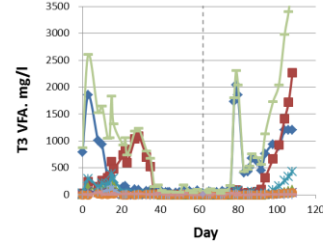
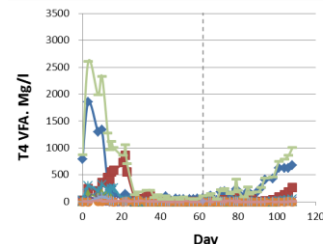

VFA accumulation in thermophilic digesters with no dilution

Trials were carried out to assess the effects of dilution in thermophilic conditions. At Soton the minimum dilution required to prevent ammonia accumulation to a critical concentration was quantified, while at JyU high loading conditions were tested, and after acclimatisation good specific methane yields of around  $0.43 \text{ m}^3 \text{ CH}_4 \text{ kg}^{-1} \text{ VS}$  were obtained with low VFA and ammonia

concentrations. In Soton study three dilutions were used to give ammonia concentrations covering the range 1.5 to 3.5 g N l<sup>-1</sup>. After acclimatisation specific methane production was around 0.5 m<sup>3</sup> CH<sub>4</sub> kg<sup>-1</sup> VS. VFA started to accumulate in the digester fed on undiluted food waste once the TAN rose above 3 g N l<sup>-1</sup>. To maintain stability dilution with ammonia-free water at < 1:1 (FW:water) is required and this has cost, energy, and resource implications.

### Mass and energy balances on full scale digestion plant

Data were gathered over the project period for two full-scale digesters: these were the South Shropshire biowaste digester at Ludlow, UK operated by Greenfinch and the Valorsul AD plant in Lisbon, operated by Valorsul. The work programme has also developed a common platform for data collection, handling and analysis which is now fit for purpose and is currently being used in the assessment of other pilot and full-scale food waste digestion plants.

The results of the work show that the input food waste material entering the two plants is very similar in its total and volatile solids content, although the Lisbon plant had a higher level of contamination due to the nature of the collection schemes serving it. Both plants operate at similar organic loading rates and the mass balance calculations based on wet weight could account for between 94-96 % of the input material.



*900 m<sup>3</sup> mesophilic digester, buffer tank, gas storage and digestate storage at the South Shropshire plant*



*Two 3500 m<sup>3</sup> thermophilic digesters at the Valorsul AD plant in Lisbon*

There were major problems in obtaining a nutrient balance, and in particular in accounting for phosphorous which at the Biocycle plant showed a 73% deficit. Both processes showed favourable energy balances although energy was lost through unused heat. The greater parasitic load at the Valorsul plant was associated with a more complex pre-processing and the need to separate the solids from the digestate and treat the supernatant liquors before discharge to drain. This operation at the Valorsul plant accounted for 40% of the parasitic electrical usage, but was unavoidable because of national regulations on digestate reuse.

### Small-scale biogas upgrading systems

*Successful development of a low-pressure low-cost upgrading system for biogas flows of 10-60 m<sup>3</sup> hour<sup>-1</sup>, and automation of a small-scale system able to meet new the Indian standard for biomethane*

Metener started work on the development of a low cost low pressure gas upgrading system started in 2010 shortly after the beginning of the VALORGAS project. A first pilot column was constructed and tests runs were carried out at a very low pressure of 0.04-0.12 bar using pure water. The advantage of a pressure of less than 0.5 bar is that the Pressure equipment directive (97/23/EC)



does not apply. The highest methane content achieved was 86.6% which could be used in CNG vehicles; however the water flow required was very high compared to the raw gas flow, making the system uneconomic. In 2011 trials were carried out at a higher pressure of 1-4 bar and with pure water. This time the water flow was reasonably low and a very good methane concentration of 97.8 % was achieved. When water recycling was attempted, however, the performance was poor with a low methane content (76.0 %) in the upgraded gas, suggesting that a desorption unit is needed to treat the water before it can be used again. In 2012 a new advanced pilot column was constructed based on the experience gained from the first pilot column, A desorption and water recycling system was developed in order to recycle all water used in the upgrading unit. Combined use of the pilot column and desorption system with water recycling proved to be effective and a high methane content was achieved in the upgraded gas (96.2 %). The system was used with a range of different process parameters to find most economic settings as reported in deliverable D5.4. The upgraded gas was channelled back to the gas grid after analysis.

Consideration was given to utilising carbon dioxide from the desorption unit, and measurements of gas quality were made. Due to air flow to the desorption column, however, the CO<sub>2</sub> concentration in the resulting gas mixture was too low concentration. If air is not channelled to the desorption unit then the upgrading performance will be seriously hampered. It was therefore proposed that for CO<sub>2</sub> capture the alternative technique of amine scrubbing should be used for gas upgrading, as this allows almost pure CO<sub>2</sub> to be recovered from the desorption column.

In 2013 work started on development of an automatic system for control of the pilot columns: prior to this the columns were under manual control and continuous action by the operator was required to adjust water and gas flows. A flash unit was added to the upgrading system to recover methane absorbed in the process water, resulting in lower emissions to the atmosphere.

A Vehicle Refuelling Appliance (VRA) was added to the upgrading unit to fill vehicles at up to 200 bar. This required development of automation, gas drying and odourisation systems which are needed when pressurising biomethane. This work culminated when the first completely automated and instrumented prototype upgrading unit was finished in early July 2013 and successful vehicle fillings were carried out with the VRA. Over 100 m<sup>3</sup> of upgraded gas was produced with completely closed water circulation demonstrating the efficiency of the water regeneration system.

The prototype unit had redesigned absorption and desorption columns able to be fitted into many different-capacity versions, from 10-60 m<sup>3</sup> hour<sup>-1</sup> of raw gas. Small-scale upgrading units of 10-20 m<sup>3</sup> hour<sup>-1</sup> can be fitted with an affordable VRA keeping the total cost of the system at a reasonable level. Another advantage of this set-up is that VRAs can be added to the system in a 'plug and play' style, making capacity increases easy. The flow rate for one VRA is 5 m<sup>3</sup> hour<sup>-1</sup> and it has its own PLC and automation systems. The upgrading unit was fitted with a 170-litre high pressure gas storage for upgraded and pressurised gas at 200 bar in order to quick fill 1-2 vehicles in few minutes. With gas storage installed, the upgrading unit and VRA can be used without a vehicle attached to the filling hose, giving increased flexibility. For example one vehicle and 170-litre storage can be filled to 200 bar simultaneously overnight and next morning another vehicle can be quick filled from the full storage. If needed the high pressure storage can be expanded to accommodate more vehicles and additional VRAs. The automation system was



System control interface



Volvo S60 Bi-fuel receiving biomethane



designed to be user friendly with 'start' and 'stop' buttons. After the system has been properly fine-tuned there is no need for the user to change the process parameters. If needed a special subroutine in the PLC can be activated which will automatically adjust parameters to achieve the desired methane content.

Maintenance of the upgrading system is possible with basic plumbing equipment and tools, as the highest pressure used is less than 8 bar. VRA maintenance is slightly more complicated but the manufacturer (or import company) can send a service person to the location. The VRA can also be quickly disconnected from the upgrading system and sent to the service point by minivan. The only drawback in combining the upgrading system with a VRA is that the gas pressure has to be reduced from 6 bar upgrading pressure to 50 mbar to meet the VRA requirements: this leads to some energy loss as the energy in the upgrading pressure is lost. As part of its post-project exploitation activities Metener has plans to overcome this problem by developing its own pressure booster unit which can utilise the 6 bar upgrading pressure, making the overall system more energy efficient.

Several analyses of biomethane were carried out during the test period. Measurements were made using a with Geotech GA 2000 gas analyzer with infra-red detectors for methane CH<sub>4</sub> and carbon dioxide CO<sub>2</sub> and a chemical cell for hydrogen sulphide H<sub>2</sub>S. In addition methane concentration was determined by an online gas measuring instrument (SIMTRONICS GD10) that was used to record upgrading performance to PLC. Gas samples were collected from the gas stream entering the VRA unit. Analysis of gas quality on gas entering the VRA unit showed it exceeds current legal and national requirements for biomethane to be used in CNG/NGV vehicles. As the biomethane after upgrading is odourless, an odourisation system is used to add a distinctive odour to the biomethane to allow detection of gas leaks.

During the tests the system was used for approximately 20 hours and 100 m<sup>3</sup> of biomethane was produced with the unit. This gas was then pressurised with the VRA and filled into the CNG/Biomethane vehicles. Several different vehicles were filled with biomethane: VW Caddy Ecofuel, Volvo V70 Bi-Fuel, BMW 328 converted to CNG, Volvo S-60 Bi-Fuel, Volvo S-70 Bi-Fuel and Mercedes Benz Sprinter natural gas (a monofuel vehicle, company van and 1000 km range with full biogas tank). All drivers reported good performance.

In parallel work in India, IIT successfully automated its gas upgrading system to meet the new Indian standard for biomethane with methane content > 90% and ≤ 20 mg m<sup>-3</sup> moisture. The biogas produced was used in a car supplied by MNRE and successfully test driven for 15,000 km.

### Studies on biogas upgrading & utilisation in India

*IIT Delhi carried out a series of linked studies to assess the potential scale, optimum modes and preferred scenarios for biogas upgrading and bottling in India, including identifying obstacles, proposing solutions and presenting a roadmap for utilisation.*

**Estimated quantities of biogas production in India:** There is huge potential for the installation of medium to large-size biogas plants in the country depending upon the availability of the feedstock. The potential can be translated to an aggregated estimated capacity of approximately 48383 million m<sup>3</sup> of raw biogas annually.

**Scale of operation:** Upgrading and bottling of the small volumes of biogas produced in family-size biogas plants is neither energy-efficient nor economically viable. On the other hand, industries such as pulp and paper manufacturing, distilleries, food processing and wastewater treatment produce enough biogas at a single site to make large-scale upgrading and utilisation a practical option. In

Biogas Generation Potential	
million m <sup>3</sup> year <sup>-1</sup>	
Animal Manure (Cattle Dung)	14792
Poultry waste	160
Crop residue and agro- waste	16717
Vegetable market waste	4000
Food waste/canteen waste	5780
Municipal waste	3369
Distilleries	1507
Dairy Industrial Waste	80
Pulp and paper industry	153
Sugar Industries	1277
Slaughterhouses	548
<b>Total Raw Biogas Potential</b>	<b>48383</b>

the middle are medium-size producers like cattle sheds and dairy farms, canteens, hostels, community kitchens and toilets, and institutional and community biogas plants. Development of small-scale biogas upgrading and bottling technology has a critical role to play in accessing the potential of these medium size producers.

**Options for utilisation:** Upgraded biogas is equivalent to natural gas, and its utilisation is therefore strongly linked to that of compressed natural gas (CNG). Use in transportation is still relatively limited in India, with an estimated 1.1 million natural gas vehicles on the road. Until now the main market for CNG vehicles has been through after-sales conversion using certified kits. Recently, however, majors such as Tata, Maruti Udyog, Swaraj Mazda, Ashok Leyland and Hindustan Motors have begun indigenizing the technology and launched new products in all categories of private passenger cars, 3-wheelers and light goods vehicles (LGV), and buses. In urban areas the CNG programme is linked to plans to augment public transport systems, offering the potential for grid injection by large-scale biogas producers but also for CNG replacement by biomethane from small-scale upgrading and bottling where there is no grid: at present only 51 cities in India have natural gas grids. In rural areas the majority of vehicles are LGV or tractors: India is the world's largest producer of tractors, but the lack of CNG infrastructure means there are no CNG models. The potential for biogas production from agro-wastes makes this a key market both for small-scale biogas upgrading and bottling and for adaptation of CNG technology to the agricultural vehicle sector.

**Evaluation of scope:** The study considered the extent to which upgraded bottled biogas could replace the range of petroleum-based fossil fuels used in the transportation and cooking sectors. Based on the total potentially available volume, upgraded biogas could contribute 807503 TJ year<sup>-1</sup> (244 GWh year<sup>-1</sup>). Economic evaluations showed, however, that cooking is currently a more favourable option for small-scale production and bottling and for replacement of LPG.

**Success stories:** Case studies were carried out on biogas production facilities at Nasik in Maharashtra, Abohar in Punjab and Tohana in Haryana for upgrading plants ranging from 5–50 m<sup>3</sup> hour<sup>-1</sup>. The results provide examples for entrepreneurs and end users, while more detailed data from IIT Delhi's experimental pilot plant has also been used in modelling and as a data set for economic and life cycle assessment.



Upgrading plant



Trolley and cylinders



Biogas vehicle

**Scenarios and barriers:** Two sets of scenarios were proposed for the adoption of small-scale biogas bottling (see box). Barriers were identified as regulation, authorisation and standards; feedstock issues; investment cost and payback; and technical capacity. IIT Delhi also contributed to development of the new Indian Standard *IS 16087 (2013): Biogas (Biomethane) - Specification*.

## Scenarios for adoption of bottled biogas in India

### I: Captive/in-house use

**Model a:** in rural areas (Cattle sheds, dairies)

**Model b:** in communities like hostels, fruit and vegetable markets, marriage halls, community toilets, hospitals etc

**Model c:** in urban areas serving housing societies/housing clusters  
(excess production can be sold outside)

### II: Selling bottled biogas as a fuel

**Model a:** at location remote from waste production site (collection and transport to a central site for biogas production and upgrading)

**Model b:** Mobile upgrading and bottling system for cluster of villages

**Model c:** in urban areas serving housing societies / housing clusters

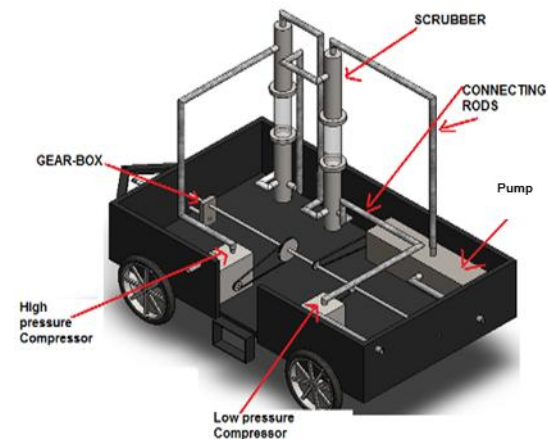
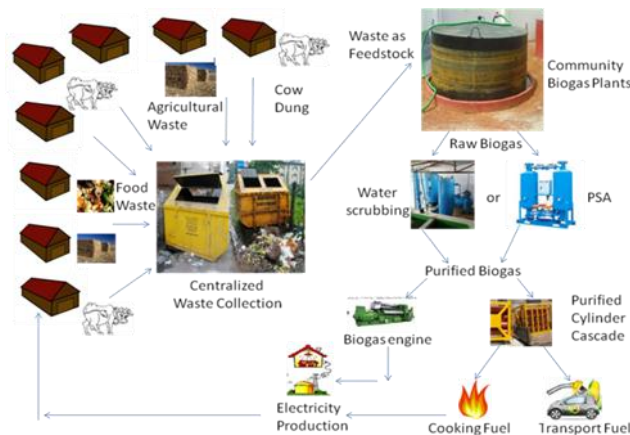

**Recommendations and road maps:** A set of 22 recommendations was put forward for successful development of the small-scale biogas upgrading and bottling industry, with a roadmap for biogas upgrading and bottling technology use in India. Input to these was gathered in a series of workshops and events associated with VALORGAS and other projects. These culminated in an international dissemination workshop at IIT Delhi on 'Promotion of Biogas Upgrading & Bottling in India & Europe' on 22-24 August 2013. The workshop was attended by entrepreneurs, consultants, project developers, technology end-users and policy makers from the Ministry of New and Renewable Energy (MNRE) and their recommendations for successful commercialisation of this technology were presented to MNRE and the Indian Council of Agricultural Research.

### Biogas upgrading technologies and applications in Europe

*Extensive reviews of technology supported by case studies indicated the need for low-cost low-flow upgrading systems ( $< 50 \text{ m}^3 \text{ hour}^{-1}$ ), while also providing an information source for industry.*

**Technologies:** Biogas upgrading and bottling technologies in use in Europe and elsewhere were reviewed, including storage and dispensing systems. The five main types of upgrading technology in commercial use in Europe are chemical absorption, water scrubbing, pressure swing adsorption (PSA), cryogenic processing and membrane separation. Of these, water scrubbing is widely regarded as the most promising for small-scale applications due to its simplicity, high methane purity ( $>96\%$ ) and yield (98-99.5%) at relatively low cost.

**Production and use:** Total biogas production in Europe in 2011 was 117 TWh as raw energy, while predicted production in 2020 based on National Renewable Energy Action Plans is about 302 TWh.

In 2013, there were more than 234 upgrading plants in operation in Europe with a total upgrading capacity of 205,716 m<sup>3</sup> hour<sup>-1</sup> raw biogas. Most of these are located on large-scale biogas production sites. The majority of biogas, however, is produced on sites that generate relatively small volumes (50-200 m<sup>3</sup> hour<sup>-1</sup>). In the last few years, the number of small-scale upgrading units in Europe has increased but there are still only 38 units of 50-100 Nm<sup>3</sup> hour<sup>-1</sup> capacity and 15 of < 50 Nm<sup>3</sup> hour<sup>-1</sup>, confirming the need for development of effective low-cost systems in this range.

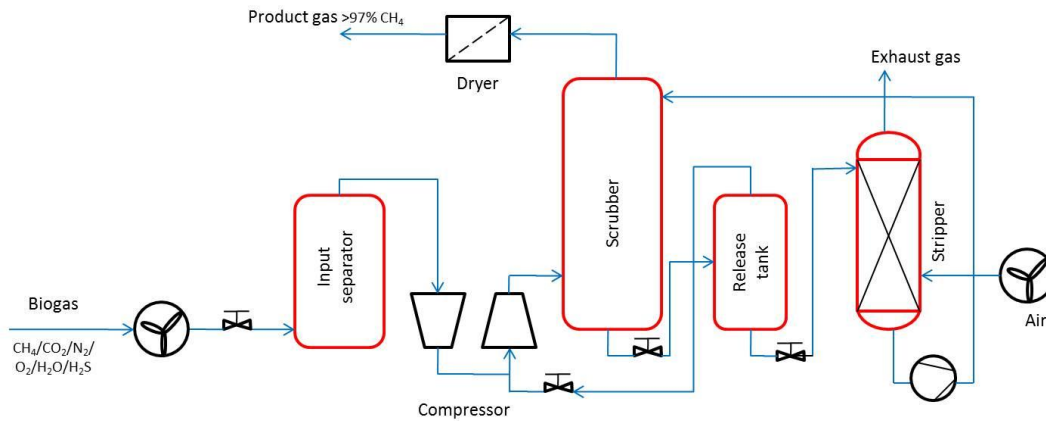

Flowsheet for water scrubbing technology

The European Expert Group on Future Transport Fuels concluded that biomethane in Europe should be fed into the natural gas grid, to avoid parallel investment in bottling and distribution networks. There are exceptions to this, however, when there is no local grid or the cost of upgrading and connection is too high. Bottling is uncommon in Europe, and the main options are thus local upgrading and dispensing or use in combined heat and power (CHP) plants: the relative energy benefits of these were considered in the VALORGAS project. Grid injection is currently carried out in only 9 European countries: Austria, France, Germany, Netherlands, Norway, Sweden, Switzerland, UK and recently also in Italy, but 'greening' of the gas grid via biomethane is expected to expand in future. A European Standard is now being developed encompassing biomethane and natural gas as vehicle fuels, and biomethane for grid injection.

**Use in transportation:** The research considered the significance of and main factors driving biomethane use in transportation in Europe, including trends in overall and renewable energy consumption. The transportation sector presents particular challenges with respect to reducing its own GHG emissions and switching to alternative fuels.

The natural gas vehicle (NGV) market is expected to grow significantly in Europe in the short, medium and long term (2020, 2030 and 2050), to reach total market shares of 5%, 9% and 16-20% respectively in both passenger and freight transport for all transport modes. There are currently more than 1.7 million NGVs in Europe (EU/EFTA), and this is expected to rise to 15-16 million vehicles by 2020, creating a large potential market for small-scale local upgrading and distribution systems of the type developed by Metener Ltd, Finland.

Among the European countries, Sweden is the leader in biomethane for vehicle fuel use. The share of biomethane as a vehicle fuel in the NGV market is 60% in Sweden, 50% in the Netherlands, 25% in Finland and 20% in Germany. There is tremendous potential for use of biomethane in local transport, especially in countries where local or regional governments are responsible for both waste management and operation or procurement of public transport. In the EU-27 alone there is a potential market of 2 million city buses that could be powered by biogas, requiring an estimated 500 TWh of energy. The role of small-scale biomethane producers in this is still limited, however. Sweden



is at the forefront of small-scale production and use in local transport vehicles, with 7 units of  $< 100 \text{ Nm}^3 \text{ hour}^{-1}$  capacity supplying biomethane for fleet vehicles or local buses, taxis and private cars.

**Case studies:** Case and feasibility studies of small-scale upgrading for use in transportation were carried out at 9 sites in Europe, with assessment of the economics of small-scale upgrading at two sites. For these plants upgrading to natural gas quality and injecting into the grid or using it as fuel at a commercial gas station is not feasible due to the costs of quantity and quality control. However, other conditions apply when the gas is used locally within a small community or on a farm. Small-scale upgrading can be made more economically viable by reducing the electricity and water costs, upgrading at low temperature (15-20 °C), use of low cost high pressure storage containers and compressing to high pressures (250-270 bars).

Study site	Country	Technology	Capacity $\text{Nm}^3 \text{ hour}^{-1}$	Operating since
Pucking	Austria	PSA	10	2005
Kalmari farm, Laukaa	Finland	Water scrubber	50	2002
Lilla Edet, Trollhättan	Sweden	PSA	30	2010
Nynäs gård	Sweden	Water scrubber	10	2003
Plönninge	Sweden	Water scrubber	20	2008
Ulricehamn	Sweden	PSA	20	2003
Otelfingen	Switzerland	PSA	50	1998
Rümlang	Switzerland	PSA	30	1995
Samstagern	Switzerland	PSA	50	1998
Collendoorn	Netherlands	Membrane	50	1990

Recommendations for promotion of biomethane use in local transportation in Europe have been circulated to industry stakeholders to encourage exchange of non-commercially sensitive information and promote interaction on industry issues

### Digestate use and biosecurity

*There is increasing awareness of environmental and health issues surrounding agricultural production, and equal concerns over the depletion of natural resources and the need to adopt a circular economy closing the loop between urban use and agricultural production. The VALORGAS programme researched the interface between these two issues by investigating techniques to protect animal and public health whilst at the same time producing a sustainable source of nutrient and organic carbon back to the soil with protocols to provide quality assurance*

Anaerobic digestion is conservative with respect to nutrients with phosphorus and potassium remain unaltered by the process whilst organic nitrogen is degraded and plant available ammonium nitrogen ( $\text{NH}_4\text{-N}$ ) is formed but not lost from the digestion system. Food waste digestates supplied by UK, Italian and Portuguese partners were all rich in  $\text{NH}_4\text{-N}$  and gave a better rye grass yield than was estimated based on the  $\text{NH}_4\text{-N}$  concentration when using inorganic fertiliser as a comparator.

Waste management activities are strictly controlled and the quality of digestate throughout Europe is regulated by EU Directives, member state legislation to enact these, and national standards. Nevertheless, if abuse of these measures resulted in damage, restrictions on use could become a preferred option to eliminate entirely any risk that digestates could weaken plant growth, damage soil quality, affect crop use, or endanger health. To maintain the excellent record of digestate usage, new input materials should be evaluated before their widespread use in digestion processes. It is only relatively recently that food waste has become a major input material, and as part of the experimental programme the research evaluated any potential risks and the measures in



place to control these. Of long term concern are impurities such as heavy metals which might arise from the food production chain and be recycled to soil during land application. Immediate risks arise from the pathogens that can be found in food waste substrates. Of these, Salmonella, *E. coli* and enterococcus are controlled by the EU's Animal By-product Regulations (ABPR) (EC 1069/2009 and 142/2011). Food waste samples and digestates were checked against these prescribed standards and in all cases tested were within the EU limit values. As there is no EU Directive governing the use of digestates, other than those derived from sewage sludge, there is no overriding standard for heavy metal concentrations and concentrations of these were therefore compared to limit values in national legislations. All food waste digestates were within the limits set in Finland and UK, but Portugal's proposed legislation has stricter limits when material is used as an agricultural fertiliser.

The ABPR permits alternatives to pasteurisation providing that equal effect can be shown. Of the two pre-treatments tested, only one achieved the required standard. This was autoclaving, where application of a temperature higher than the ABPR value (160 °C compared to 70 °C) resulted in a pathogen-free material. The cellruptor technology was much less effective and an equal effect to pasteurisation could not be demonstrated. The use of the autoclave, however, changed the nature of the food waste to a point where a proportion of the organic nitrogen could not be broken down in the digestion process. It was further confirmed that this unmineralised nitrogen in the digestate was not available to plants, reducing the fertiliser value by approximately 30% compared to the control. No adverse effects were noted on the plants tested, but the volume of digestate needed to achieve the desired fertiliser effect is substantially increased.

The practical limitations and economics associated with food waste digestate utilisation were assessed through a case study carried out using data from Andigestion's AD plant at Holsworthy, UK. The plant was originally designed for animal manures but since 2008 only food wastes have been processed. The digestate has a high pH, low dry matter content and a high proportion of potentially crop available nitrogen, making it attractive to farmers as a replacement for expensive mineral nitrogen.

The farmers are aware of the properties of digestate and confident in its safety. Nitrogen in this form, however, has to be carefully managed if it is to be taken up by the crop and not lost to the environment where it can cause harm. Farms in the UK using digestate under 'waste' status rules must provide recent soil samples from the land to be spread so that nutrient recommendations can be made: this type of testing is now routinely carried out. Matching supply with demand is always problematic unless a large storage capacity is available. The area around Holsworthy is predominantly grassland and closed

Holsworthy digestate - key constituents		
Analysis	Value	Unit
pH	8.4	-
Dry matter	4.6	%
Total nitrogen*	6.3	kg m <sup>-3</sup>
Ammonium nitrogen	5.9	kg m <sup>-3</sup>
Phosphate	1.1	kg m <sup>-3</sup> P <sub>2</sub> O <sub>5</sub>
Potash	1.4	kg m <sup>-3</sup> K <sub>2</sub> O
Magnesium	0.1	kg m <sup>-3</sup> MgO
Sulphur	0.9	kg m <sup>-3</sup> SO <sub>3</sub>

\* Application limit 250 kg N ha<sup>-1</sup> ( 39 m<sup>3</sup> ha<sup>-1</sup> )

to digestate spreading while silage making is in progress or when the ground is too wet. The demand is therefore in late spring and intermittently throughout the summer between grass cuts. There is little demand in autumn as there is no crop nitrogen requirement for winter cereals, and in winter grassland spreading is limited by ground conditions. The AD plant must therefore have storage capacity for most of the year's production.

Actual crop requirements for productive grassland, and the amount of digestate needed to meet these, were calculated based on the production of a first cut silage with a yield of 23 tonnes ha<sup>-1</sup> at 25 % dry matter. After taking into account N losses and carry over to the next cut, digestate could supply 90% of the estimated crop N offtake and make savings of around 140 € ha<sup>-1</sup> based on the cost of supply of inorganic N fertiliser. The value of nutrients in one cubic metre of digestate is only around 7.20 €, however, making post-treatments to reduce volume, increase ease of application and improve digestate properties an attractive area for further research.

## Overall energy and emissions balances

The research culminated in development of a modelling tool for determining the energy balance from anaerobic digestion of food waste and other organic wastes; and use of this in conjunction with the WasteCAT model to assess the overall benefits of valorisation of food waste to biogas

A key goal of the VALORGAS project was to develop a means for assessing the overall energy balance from collection, pre-processing and anaerobic digestion of FW, through to utilisation of the digestate and the biogas fuel product; and to apply this to selected scenarios to determine the benefits or otherwise from valorisation of source segregated domestic FW to biogas. For this purpose two tools were used: the WasteCAT collections model developed in WP2, and a modelling tool for anaerobic digestion of organic wastes. The former was run with a range of scenarios to identify a 'typical' value for the extra energy requirement of source segregated FW collection, which could then be used in assessing the energy balance for the whole system. The latter was based on a model originally developed in the FP6 CROGEN project, and extended in the current research. The work made use both of literature data and of results and experience gained during the VALORGAS project. Results from the two models were then combined to give a whole system assessment.

**Energy balances for digestion plant:** The AD modelling tool was used to simulate a set of 16 scenarios based on the following options: biogas utilisation for electricity and heat production in a CHP unit (e), or for methane production through biogas upgrading (u); operation of the AD plant at mesophilic or thermophilic temperatures (M or T); 'simple' or 'complex' digestion process (S or C, based on the degree of pre and post treatment of the feedstock and digestate); and feedstock input of 2,500 or 10,000 tonnes year<sup>-1</sup> (2 or 10).

The total exportable energy was slightly higher for scenarios involving electricity and heat production than for biomethane and heat, due to the assumed energy conversion efficiencies and embodied energies for each technology. In many locations, however, finding a use for surplus heat is highly problematic. The net energy output for the electricity-only options is much lower, as electricity produced via CHP accounts for only 35% of the energy in the consumed biogas. Upgrading is more efficient in terms of producing energy in the preferred form and is thus a better option if there is no use for the heat produced by the CHP unit.

**Overall energy and GHG balances:** Results from the AD modelling were combined with output from the WasteCAT model to establish the overall energy and emissions balances of a set of scenarios covering the complete system of FW collection, processing and use of digester outputs.

The 8 scenarios included simple and complex AD systems, mesophilic and thermophilic operation, for electricity or methane production, all with a FW input of 2,500 tonnes year<sup>-1</sup>. In almost cases considered the net energy production was positive, i.e. the energy derived from the collection, transport and AD of FW including pre and post-processing and utilisation of the digestate and energy products is greater than the fossil fuel derived energy consumed. The only exceptions to this are where the biogas is used to produce electricity via CHP with no potential to export the heat.

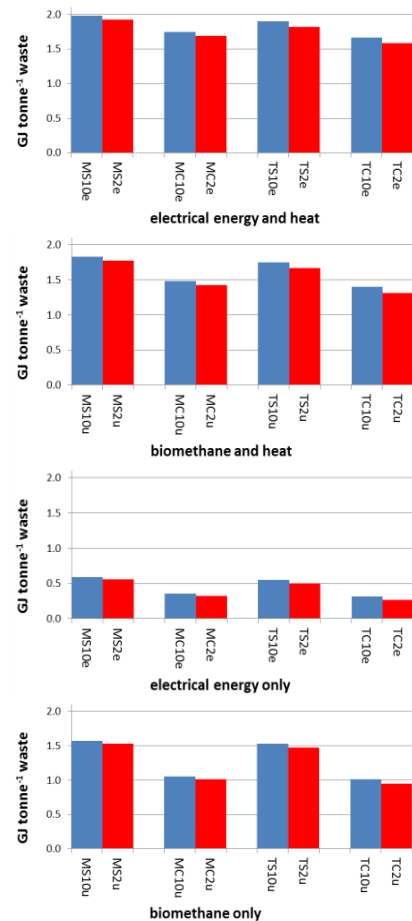

This is due to the relatively low energy conversion efficiency for electricity (35%), and can be compensated for by the use of 10-33% of the heat generated. All of the scenarios involving upgrading of biogas to methane show a positive energy balance, indicating this is a rational means of valorisation especially for small-scale distributed sources of waste, and justifying the focus on small-scale biogas upgrading in the VALORGAS project. In all cases considered there is a net savings in terms of GHG emissions through replacement of fossil fuel generated energy. This is to be expected, as relatively small amounts of fossil fuel energy are being consumed compared to the amount of energy generated as electricity, heat or biomethane.

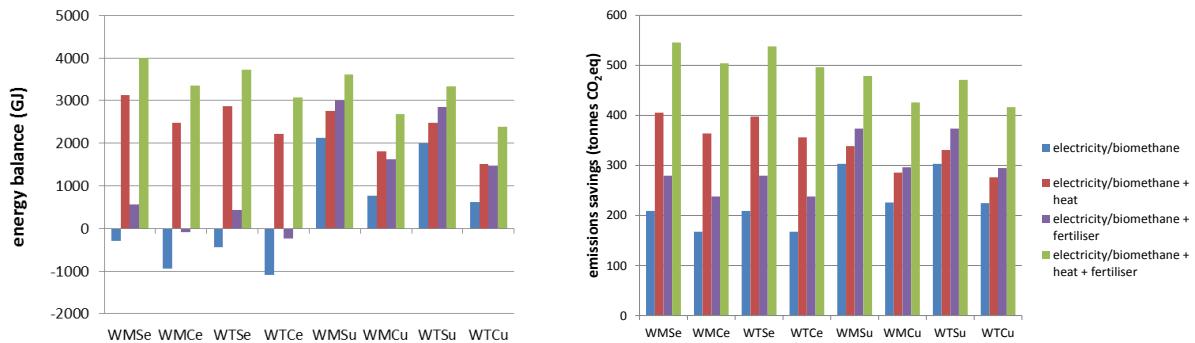

Overall energy and GHG balances (*W* = whole system)

The current scenarios considered small-scale plants with an input of 2,500 tonnes year<sup>-1</sup> of source segregated domestic FW. Larger schemes processing more FW may show energy balances that are slightly higher, due to minor increases in efficiency with scale. Further modelling would be needed, however, to consider the effect of any increase in the transport distance required. Energy and emissions in collection and transport depend on a wide range of factors, including ones such as population density and terrain that are specific to the location and cannot easily be 'optimised'. The indications from the current whole system assessment, however, are that the energy potential of FW as an AD feedstock is sufficient to give positive energy and GHG emissions balances in any of a wide variety of typical scenarios. The value of the modelling approach used is that it allows comparative assessment of the consequences of choosing options such as mesophilic or thermophilic temperatures, and simple or complex operation with or without export of heat and utilisation of digestate as a fertiliser replacement.

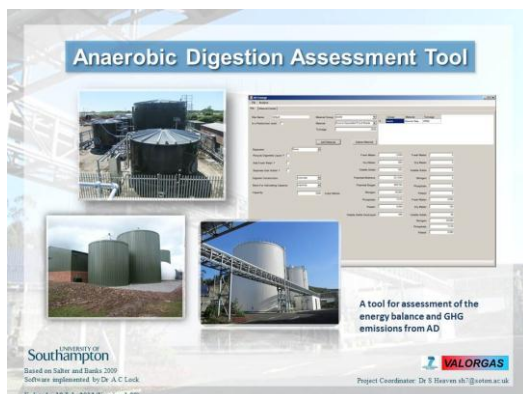

A software version of the AD modelling tool has been produced and is now in beta testing. When used in conjunction with the WasteCAT tool, this allows rapid simulation and assessment of a very wide range of waste collection and AD scenarios.

The work reported here focusses mainly on the energy balance, as this is the main goal of the VALORGAS project; but the approaches adopted can be used to support decisions based on a wide range of factors in terms of cost, resources and environmental impact. The output from scenario modelling is not a single answer that will be correct in all cases: the optimum solution for a given scheme depends on its specific features, and in practice the choice made will be strongly influenced by cost and acceptability. The combined modelling tools provide a robust and rational means of exploring the consequences of different choices in terms of energy, GHG emissions and nutrient, and thus offer support to the decision-making process.

## Impact

### ***Overall contribution of the project to EU priorities and initiatives***

The research carried out was directly aligned to a number of key EU policies and targets. The EU Directive on the promotion of the use of energy from renewable sources (2008/0016 (COD)) established an overall binding target of 20% for renewable energy sources in consumption and a 10% binding minimum target for biofuels in transport, as well as binding national targets by 2020. Achieving these targets would reduce fossil fuel consumption by over 250 Mtoe per year, and annual CO<sub>2</sub> emissions by 600-900 Mtonnes. The EU Biomass action plan (COM(2005)628) estimated that if the full potential of biomass was achieved this could contribute about 185 Mtoe of renewable energy, of which an estimated 100 Mtoe was available as organic wastes, including forestry and agricultural residues and food waste. Food waste is therefore recognised as having a major role to play in meeting these renewable energy targets, and the project has played an active part in promoting this through its research and dissemination activities.

The research paid particular attention to methane as a biofuel for vehicle use. According to Directive 2008/0016 (COD), the transport sector presents the most rapid growth in GHG emissions. Biofuels address the oil dependence of the transport sector, which is one of the most serious problems of energy supply security facing the EU; but they are currently more expensive to produce than other forms of renewable energy, meaning there is an urgent need for research focused on reducing production costs. The EU Biomass action plan also highlighted the fact that the use of biofuels in transport has the highest employment impact. Under the Biofuels directive (2003/30/EC), the target was to replace 5.75% of all petrol and diesel transport fuels by renewable fuels, equivalent to a demand of 18.6 Mtoe. This included bio-ethanol and bio-diesel, which are predominantly produced from higher-value extracted parts of plants and are therefore referred to as first generation biofuels. On 11 September 2013 a narrow majority of MEPs voted that "first generation" biofuels should not exceed 6% of the final energy consumption in transport by 2020, as opposed to the current 10% target; while advanced biofuels (second and third generation) should represent at least 2.5% of energy consumption in transport by 2020. This follows the publication in October 2012 of a proposal to minimise the climate impact of biofuels, by amending current legislation through the Renewable Energy and the Fuel Quality Directives. The proposal suggests limiting the amount of food crop-based biofuels and bioliquids that can be counted towards the EU's 10% target for renewable energy in the transport sector by 2020, to the current level of 5%, while keeping the overall renewable energy and carbon intensity reduction targets. To achieve this it is proposed that market incentives should be introduced to promote biofuels with no or low indirect land use change emissions, and in particular second and third generation biofuels produced from feedstock that does not create an additional demand for land. Bio-methane is regarded as a liquid biofuel and its production from foodwaste gives it second generation status. Since its conception the VALORGAS project has promoted the use of waste in preference to purpose-grown biomass, and the research output has already shown how food waste can contribute towards the new proposals outlined above. Furthermore, process improvements developed as a result of the research have shown that anaerobic digestion can easily match the 60% minimum greenhouse gas saving threshold set for new biofuel installations.

The research has paid particular attention to how AD technology could be adopted at a local level in order to meet the objectives of the EC Green Paper 'Towards a European strategy for the security of energy supply' (COM(2000)769), which highlights the importance of renewable sources. In this area the research has had a number of impacts, and the progress made on development of small-scale biogas upgrading systems is particularly pleasing: a low pressure system developed as a result of the



VALORGAS project is now entering the market place. Likewise the WasteCAT and ADtool software tools have provided means by which designers and operators of second generation municipal biowaste systems can optimise waste collection, processing and product utilisation to maximise energy gains and minimise environmental impacts. These tools are already in user-friendly format and are immediately available to support appropriate scale developments.

One tonne (wet weight) of food waste yields around 100 m<sup>3</sup> of CH<sub>4</sub>, approximately equivalent to 1000 kWh or 100 litres of diesel. There are still no accurate figures for the quantity of food waste produced in Europe each year, apart from overall collated by Eurostat. Previous estimates for the UK suggested it makes up ~24% of the waste generated in each household or around 6.7 million tonnes, with a further 10.0 million tonnes from the food industry, commercial and agricultural sectors (excluding animal slurries), giving an annual total of ~320 kg per person. Since the first food waste anaerobic digestion plant commenced operation in the UK in 2007 another 110 plants have been installed taking UK food waste digestion capacity to 2.07 Mtonnes. 34 of these plants have been installed in the past year, and a further 200 planning applications have received approval. This rapid development has been assisted by research undertaken in the VALORGAS project which has solved operational issues relating to process stability and promoted good practice through its dissemination activities. There is now a firm commitment in the UK to support food waste digestion, and although still only 7% of food waste is treated by this route the current rate of growth suggests that the aspirational targets presented in the project proposal are achievable in the short term. The VALORGAS project and the related research that led to this have therefore had a massive impact in the UK simply by initiating the concept and supporting its development through continued research. If this uptake can be mirrored at an EU level there is the potential to generate 12.86 Mtoe of vehicle fuel, equal to 62% of the 5.75% target, and 35% of the 2020 target of 10%. It is also roughly 3 times EU biodiesel production in 2005, and equates to a saving in crop area of 5.4 million hectares or 5.6% of Europe's agricultural area. The VALORGAS project has drawn attention to the implications of different types of collection system in targeting different feedstocks, and added to the growing interest in AD of source segregated food waste through dissemination and widespread discussion of the results.

Food waste digestion can also make a significant contribution to carbon abatement. In this case the impact is direct, as the production of renewable energy offsets emissions by replacement of fossil fuel, and the carbon savings are also fully tradable. Support for this is provided through the EU Emission Trading Scheme (ETS), indicating the importance the Community places on emissions avoidance. The ETS is based on Directive 2003/87/EC, which came into force on 25 October 2003, and is the world's largest multi-sector Greenhouse Gas trading scheme. The contribution through direct offsetting, which is quantifiable through the ETS, does not take into account avoidance of fugitive emissions that could occur if the waste was disposed of to landfill; but as an example if the tonnage of food waste generated in the EU27 was disposed of via this route in an uncontrolled manner the GHG emissions on an annual basis would be around 235 million tonnes CO<sub>2</sub> equivalent. This scenario was included in the proposal but was noted as being 'artificial', since disposal of such material to landfill should decline by 2020 in accordance with the requirements of the Landfill Directive (1999/31/EC). The potential of food waste digestion to accelerate this decline is now drawing governmental attention, particularly in the UK. In September 2013 shadow environment secretary Mary Creagh stated that, if elected, the Labour party would introduce a ban on sending food waste to landfill - a policy that many believe will encourage further investment in AD. The coalition government has also committed to considering landfill bans during the course of this parliament. This strengthened commitment to the avoidance of fugitive GHG emissions from landfill is a direct result of AD of food waste providing a realistic alternative disposal route. The issue raised in the original VALORGAS proposal, that "These requirements, however, also pose the problem of

finding alternatives in many EU countries that still rely on landfill as a disposal route for MSW" now has a potential solution, and the VALORGAS research has provided the underpinning data to give confidence in that alternative. The positive impact of diverting food waste to energy generation is thus multiplied by the contribution to GHG reduction through providing an improved disposal route.

Other than landfilling, the main option for energy recovery from food waste is thermal processing. Table 1 compares the potential energy yields from combustion and anaerobic digestion of this material, now that key values have been confirmed by the research. The calorific value of food waste based on its lower heat value is typically around 2200 MJ tonne<sup>-1</sup> of wet weight, whereas the raw energy yield as methane is 3600 MJ tonne<sup>-1</sup>, a difference of more than 60% that strongly supports digestion as the preferred option. If the methane is used as a biofuel for transportation the energy required for upgrading in a large-scale plant is typically 3.5-9.2 % of that contained in the fuel, depending on the scale and chosen technology; with slightly higher values for smaller plants. Work carried out in the current project achieved a level of 5-7 % in small-scale technologies. In mass burn incineration the only conversion option is to electricity, and a high pressure steam turbine for this purpose may have an efficiency of 23%. The energy yield as biofuel (3240 MJ tonne<sup>-1</sup>) is thus more than 6 times that of electricity from mass burn incineration (506 MJ tonne<sup>-1</sup>). If both technologies are used for electricity generation with heat recovery, overall conversion efficiencies are similar: a combined heat and power (CHP) plant run on biogas may give 85% conversion of which 30-35% is as electricity and 50-55% recoverable heat, while a steam turbine may have an overall efficiency of 81%. In this case the energy yield of 3060 MJ tonne<sup>-1</sup> from digestion is 1.7 times more than from incineration. In practice however options for the use of energy as heat are frequently limited, and thermal processes are run to maximise the economic value through the electrical output. The results of the current research strongly support upgrading to biomethane as the preferred technology where there is no potential for heat utilisation: and as the majority of biogas is produced in small to medium-scale AD plants it is small-scale upgrading which will achieve this impact. These calculations have been further refined as part of the project and both the energy balance of the digestion process and a full system carbon and energy balance can be carried out using the software tools developed. These tools will allow a much more rapid and accurate analysis of different scenarios, the impact of which will be the development of more energy efficient schemes.

**Table 1 Energy yields from mass burn combustion and anaerobic digestion of food waste**

Parameter	Combustion		Digestion		Unit
	Electricity only	Electricity and heat	Electricity and heat	Upgraded biofuel	
Methane yield			100	100	m <sup>3</sup> CH <sub>4</sub> tonne <sup>-1</sup>
Calorific value	2200	2200	3600	3600	MJ tonne <sup>-1</sup>
Conversion efficiency	0.23	0.81	0.85	0.90	-
Energy yield	506	1782	3060	3240	MJ tonne <sup>-1</sup>
Nitrogen content			6.0	6.0	kg N tonne <sup>-1</sup>
Energy for N fixation			1000	1000	m <sup>3</sup> CH <sub>4</sub> tonne <sup>-1</sup> N
Energy gain			216	216	MJ tonne <sup>-1</sup>
Total energy yield	506	1782	3276	3456	MJ tonne <sup>-1</sup>
Estimated annual tonnage	157	157	157	157	Mtonnes year <sup>-1</sup>
EU annual energy yield	1.88	6.63	12.19	12.86	Mtoe year <sup>-1</sup>

At the proposal stage it was thought that segregation of food waste from the general municipal waste stream might offer several related benefits, including an improved potential for recovery of commodity-grade recyclables from the residual waste. The results indicated, however, that even in

successful schemes a surprisingly high proportion of the food waste remains in the residual fraction. While it was not possible to quantify the value of any directly reclaimable components as a result of lower food waste contamination, the research confirmed that the residual fraction of the waste stream will have a higher calorific value for recovery in Energy-from-Waste systems. The work thus both provides data and raises questions for future investigation, for example into alternative collection methods that could maximise capture rates without increasing contamination; and the role of combined thermal and biological treatment systems for treating the residual fraction. This part of the research has contributed towards the objectives of the European Strategic Energy Technology (SET) Plan through increasing our knowledge on the potential and limitations of supply chains derived from waste materials.

The research has confirmed that digestates from source segregated food wastes are fully compliant with norms established in European countries for land application of organically produced fertilisers, with lower levels of PTEs than those found in animal slurries and permitted under the Sewage Sludge in Agriculture directive (86/278/EEC). The results support the premise that digestion is an accepted treatment under the EU ABPR (1774/2002/EC), and provided additional evidence that this treatment route is important in ensuring bio-security, as well as meeting requirements to protect the soil from pollutants while ensuring soil function and fertility. Recycling food waste digestate to land helps to maintain (or increase) the soil organic matter content, and this issue is addressed in the EU Thematic Strategy for Soil Protection (COM(2006)231). It also returns other plant nutrients, in addition to nitrogen, to the soil and the work has quantified this contribution and the mineral fertiliser requirement that can be offset. Of particular importance is the conservation of phosphorus, as phosphate bearing ores are declining and expected to run out within the next 60 to 130 years (Steen, 1998). Other valuable nutrients returned via this process include potash, magnesium and a wide range of micro-nutrients required for healthy plant growth. By reclaiming nutrients from waste the research contributes towards the vision of a circular agriculture (SAIN, 2008) where mined or atmospherically fixed nutrients are recycled from nutrient sinks. This could have a major impact in reducing the quantity of nutrients that can potentially enter inland surface, ground and coastal waters. The issue of anthropogenic nutrient enrichment of waters in the EU remains one of the major environmental concerns (JRC - WP2004 - Action no. 2122).

### **Specific impacts**

In addition to the overall contribution to key EU strategies and policies noted above, the research outcomes have had a range of specific practical impacts.

#### *General*

- The project has overcome many of the technical problems associated with anaerobic digestion of food waste, and has made the technology more acceptable for widespread adoption, thus enabling food waste to make a significant contribution towards EU renewable energy targets for second generation biofuels. Evidence for this is seen in the rapidly expanding food waste digestion sector, especially in the UK, indicating that this new confidence is leading to extensive investment in new plant and equipment. There can be little doubt that the VALORGAS research has been instrumental in providing solutions to the problems of digester instability that were apparent in new plant commissioned between 2008-2010, and that promotion of these solutions to the industry sector has allowed a relatively 'trouble-free' expansion.

#### *Composition and characterisation of food waste*

- The research has developed a methodology for mapping between standard methods for characterisation of municipal waste streams including food waste. This has been tested in several

European countries and the documentation describing the methodology developed made publically available. The impact of this is to allow comparison of unlike data sets by putting them into a common framework, thus increasing the available data resource for better planning of waste processing facilities, including requirements for pre-sorting and final product utilisation.

- Determination of contaminant levels in waste streams and relating this to type of collection will allow better design guidelines to be drawn up for the specification of handling equipment. The documented quantitative evidence of contamination levels coming from this project is of value to companies in drawing up acceptance criteria for the reception of food waste. It also provides a benchmark against which changes to the collection system can be quantified
- Quantitative data on the use of biodegradable bags in food waste collection and the contribution these make to plant energy production makes it possible to compensate for their inclusion in any design. The data is also available for comparing collection scheme productivity where one element of difference is the provision or not of bags
- Data derived over a 3-year period has shown how participation rates change as schemes mature. This will allow better estimates to be made for planning of resources and infrastructure as well as designing outreach and educational activities.

#### *Collection systems and residual wastes*

- The web-based survey on collection schemes has demonstrated the value of this approach and methodology when geographically dispersed data is needed and resources are limited. This approach could be used in other fields.
- The surveys and quantitative work on collection systems have shown that the type of receptacle used is a determining factor in the level of contamination of the collected material. The research has linked this to digestion plant pre-treatment requirements, and this will aid in developing the concept of an integrated systems design in the future
- Through waste collection surveys Valorsul was able to strengthen its links with the municipalities collecting the waste as well as identify weaknesses in the system. This is a very positive impact as it has established a new manner of cooperation that has led to quantifiable improvements in the collection system. Similarly, sharing data with the municipality on residual waste composition has helped to improve the understanding of socio-economic factors and implementation of public awareness campaigns
- The WasteCAT tool allows optimisation of collection rounds saving energy, resources and money. This model is immediately available.

#### *Appropriate scales and feasibility*

- The wide variety of case studies carried out across public and private communities has established a dataset that will allow individuals and groups to make a preliminary decision on the feasibility of small scale digestion scheme.
- Project results are being incorporated directly into initiatives on urban micro-AD networks.

#### *Process fundamentals and stability*

- Trace element supplementation of mesophilic food waste digesters allows operation at a much higher organic loading rate of  $8 \text{ kg VS m}^{-3} \text{ day}^{-1}$ . At this loading a very high volumetric methane production of around  $3.5 \text{ m}^3 \text{ m}^{-3} \text{ day}^{-1}$  is possible. This is a four-fold increase on previously achievable loading rates, with a correspondingly major effect on the commercial and energetic viability of AD schemes, and undoubtedly is one of the major impacts of the research.
- Understanding the microbial physiology and mechanisms that control the syntrophic reactions within an anaerobic microbial consortium has opened up other potential process applications. The VFA intermediates that accumulate in food waste digesters are themselves valuable products, and manipulation of the process to promote this accumulation could provide the basis of a biorefinery. VFA themselves can be further transformed into a range of products including alternative energy



carriers such as propanol and butanol, can form a substrate for the biodegradable polymer PHA, or are products in their own right: propionic acid is used commercially as a sterilant and seed dressing and butyric acid as a bulk chemical building block in chemical synthesis. To shift the process towards formation of these products requires a much deeper understanding of the factors controlling syntrophic reactions. The research has contributed towards this, and there is now a growing interest in lower-cost 'non-sterile' approaches to control fermentation and select metabolic routes. Evidence for this new area of development can be seen in the growing number of peer-reviewed journal papers supporting this concept, and more than 10 conference presentations made at the June 2013 IWA Biannual Conference on Anaerobic Digestion. The VALORGAS programme has impacted strongly on this through the major contribution it has made to understanding the role of trace elements in mediating metabolic pathways in the anaerobic process. Further development in this area was not a direct aim of the current research, but the skills and know-how have now been embedded in the research partners and will be taken forward through applications to the Horizon 2020 calls.

- Ammonia toxicity thresholds were identified for mesophilic and thermophilic digesters as  $\sim 8$  and  $\sim 2 \text{ g N l}^{-1}$ , respectively. This quantitative determination provides digester operators with an awareness of safe ammonia concentrations, especially for those running in thermophilic conditions with the impact that fewer digester failures are likely in the future as a result of ammonia toxicity.

#### *Ammonia removal*

- Biogas side-stream stripping experiments showed that the methodology is effective in reducing the total ammonia nitrogen concentration in food waste digesters with no adverse effects on performance in terms of gas production or VS destruction. The research shows a way forward to overcome one of the technical problems associated with reliable recovery of energy from food waste, since the technique can maintain ammonia concentrations below the thermophilic inhibition threshold. One impact will be the expansion of the AD industry by making a wider range of nitrogen-rich waste feedstocks suitable for bioconversion at both mesophilic and thermophilic temperatures.
- The ability to control the nitrogen content in the reactor by altering the stripping conditions opens up the possibility of creating 'designer digestates' where the nutrient content is balanced to match local crops and soil types; while the extracted ammonia is itself a valuable fertiliser product for application during crop growth.
- At the proposal stage it was noted that designs for ammonia recovery equipment would present direct technology transfer opportunities, for example into thermophilic digestion of cattle and pig slurry where high ammonia concentrations result in similar conditions to those experienced with food waste. In fact strong interest has arisen in other parts of the agricultural sector, and the designs and concepts developed in the project are now being considered for ammonia recovery in the digestion of chicken litter. The research is thus enhancing the market for digestion systems, making them applicable to a wider range of substrate types and temperature ranges.

#### *Precipitation reactions for nutrient recovery*

- Precipitation techniques have direct applications into anaerobic digestion systems as they permit the recovery of nitrogen and phosphorus as struvite, reducing the cost of external chemicals and producing a 'slow-release' fertilizer. This enhances the market for AD systems allowing the production of energy and fertilizer. The potential for recovery of ammonia and phosphorus as a high value secondary product will also have an impact on the economics of these schemes.

#### *Autoclaving*

- Autoclaving immobilises organic N in the feedstock thus reducing ammonia formation. This may be of benefit in the treatment of high protein containing wastes, especially those that require complete pathogen destruction. The impact is the potential development of a single stream process for the treatment of wastes such as those from animal slaughter or fishmongering where current disposal systems are energy intensive.

- One of the major potential benefits of autoclaving of food waste appears to be the reduction in H<sub>2</sub>S, a highly corrosive gas, which damages engines and causes H&S implications for operatives. The use of an autoclave could therefore open up the possibility for using previously unsuitable feedstocks with the impact of increasing the potential for renewable energy production.

#### *Hythane production*

- The removal of ammonia in an intermediate processing stage allowed the development of a thermophilic anaerobic dark fermentation hydrogen production phase which could be coupled to a second methanogenic phase to deliver hythane as a final fuel product. The resulting impact is the basis for further development of an advanced fuel gas manufacturing process in a 2 phase reactor system. This would have the added benefits of ammonia recovery as a value added product and enhanced biosecurity as a result of the higher operating temperature. An alternative to producing hythane could be the co-production of hydrogen and volatile fatty acids as the basis of a biorefinery.

#### *Mass and energy balances*

- The mass and energy balances developed during the project for the full-scale mesophilic and thermophilic digesters have provided the plant operators with detailed information regarding the efficiency and effectiveness of their process design, and shown improvements which could increase efficiency in future developments.
- The work has also highlighted common errors and misconceptions, and key monitoring parameters needed to improve the reliability of future studies.

#### *Gas upgrading*

- The development of low-cost energy-efficient integrated processes for gas upgrading and bottling has been a major success of the VALORGAS project. This will increase significantly the opportunities for using biogas technology at a small scale to serve local communities, individual industrial units and farms, in adherence to the proximity principle of treating waste near its point of origin. The systems developed by Metener and IIT partners provide a mechanism where upgraded gas is available at source or in an easily transportable form, facilitating the rapid expansion of localised distribution points, especially in locations away from the gas grid.
- The work done in India has supported the development of biogas as a transport fuel and contributed towards the legislation and standards necessary to regulate the supply of upgraded biomethane to a massive market through safe and reliable local facilities. It has identified barriers and made recommendations for overcoming them, in conjunction with a wide range of industry stakeholders, and passed these to the highest levels of government. Where economic assessments are favourable, alternative routes have been considered such as use of bottled biogas in cooking.
- The scale of application in Europe is smaller, but the concept of small-scale operation with back-to-back supply contracts can be a successful model for meeting local transport needs, and small-scale upgrading equipment matched to a compression and vehicle refuelling system is already attracting market attention both in Europe and abroad (China).
- Results from gas upgrading case studies have been directly disseminated to German Biogas Association, Swedish Gas Company and individual companies in Germany, Austria etc to encourage exchange of non-commercially sensitive information and promote interaction on industry issues. By making information available on the current state-of-the-art in biogas production and upgrading for vehicle use, the research has helped to promote this sector and its potential role in contributing to the current target of 381 TWh by 2020 with a market share of 5% in the transport sector.

#### *Digestate utility and biosecurity*

- Plant growth trials have shown food waste digestate is a suitable replacement for mineral fertilizer without any loss in yield. Case studies have quantified the value based on nutrient content.

- The research has confirmed that food waste digestate is a low risk material both in terms of its heavy metal and pathogen content. The impact of this finding will be to further build confidence in the use of this material in agriculture. The result will also be of use to those involved in defining standards for land application and in the decision making process for end of waste criteria.
- Recommendations on digestate stability and utility are being fed directly into debates on national standards and regulation in Finland, Italy and the UK and being used to inform the UK regulatory approach to End-of-Waste criteria for digestate.

#### *Overall model*

- In the simplest terms CHP is the most energy efficient use for biogas if there is a locally available need for the heat produced; if not, upgrading to biomethane is a better option. The ADtool developed, however, allows comparison of multiple scenarios and determine the best energy and GHG emission related options. This has a big impact on the speed and accuracy with which these calculations can be made and use of the tool will allow system selection to fit local circumstances.

#### *Integrated processes*

- The VALORGAS research has raised the profile of anaerobic digestion as an energy technology using waste biomass from municipal sources. This has led to much greater acceptance of the technology as a potential part of an integrated thermal/biological energy recovery system and has generated research partnerships to take these concepts forward e.g. EPSRC Supergen hub project 'Increasing energy yield from the integration of anaerobic digestion and pyrolysis'.

#### **Policy uptake**

The research and findings have contributed to the development of both national and European guidance in the field of energy and the environment. The scientific understanding of the digestion process has allowed Soton to act in a consultancy role to industry in a scheme administered by the UK government-funded NGO the Waste and Resources Action Programme (WRAP). This scheme (Dr AD) was aimed at improving the efficiency of anaerobic digestion plant and advising on operational difficulties. Soton has also been participants in the consultations regarding the drawing up of a publically available specification (PAS) for digestate. Compliance with this allows the producer to meet end of waste criteria as set by the UK national government. Work carried out as part of the VALORGAS project has also been used in assessing the appropriateness of a digestate stability standard and the results of these studies are being used in the cross-European debate on End of Waste criteria. The VALORGAS work has also been influential in determining a section of the work programme for the IEA Task 37 group over the next 2 years: a request has also been made by the Task to use data from the VALORGAS research in two of their new technical guidance publications, one on digestate utilisation and the other on small scale anaerobic systems. The work on waste compositional analysis has contributed significantly to the production of guidance to local collection authorities and has also been used in developing policy regarding separate food waste collection schemes. UNIVE and UNIVR are in the process of preparing a position paper on the integration of food waste and wastewater treatment, and this is regarded as the first step in raising national governmental awareness in resource efficient digestate management as part of the circular economy. The work of MTT as a national laboratory feeds in data to government departments, which is subsequently used in the formulation of legislation. The results from the VALORGAS project on biosecurity of digestates are being communicated to Government by Prof Rintala. Prof Vijay from ITT has been an influential voice in the debate which preceded the setting of a national Indian standard (IS) for the use of biomethane in transport and in a wide range of initiatives on promotion of biogas production and upgrading. This has also taken the form of providing direct evidence to Government of India committees, including results for the VALORGAS programme.

## Dissemination and Exploitation

### Dissemination activities

The VALORGAS project involved a very wide range of dissemination activities addressing the following target audiences:

- Organisations and individuals involved in production of renewable energy from biomass and organic waste sources
- Waste management end-users (e.g. waste industry and local government organisations responsible for planning and implementation of waste management operations).
- Researchers working in the fields of renewable energy production, anaerobic digestion, collection and processing of organic wastes, biogas upgrading, local transportation, and energy and carbon modelling.
- Engineers and designers involved in the development of equipment and infrastructure for renewable energy production, anaerobic digestion of organic wastes, and resource recovery
- Local government bodies responsible for planning and regulating aspects of energy supply and security, waste management, and service provision (e.g. local transport and heating).
- Politicians and decision-makers responsible for the direction of legislative and regulatory regimes and economic policies in the fields of renewable energy and waste management
- Members of the public and of local, national and regional organisations involved in renewable energy production, biofuels in transportation, and improved resource management.

The project outputs include 12 published peer-reviewed journal and conference papers, with a further 5 in review, 18 in preparation (i.e. late draft) and 12 proposed papers. 5 PhD and 10 Masters theses were carried out in conjunction with the work, which also generated ~15 topics for undergraduate projects. Project participants took part in over 130 specific dissemination events and activities as listed in summary tables presented to the EC. Of these, there were three main project-specific events consisting of two international Summer Schools at the University of Jyväskylä in Finland, and one international dissemination workshop organised by IIT Delhi.

#### *Jyväskylä Summer Schools 2011 and 2013*

The first special dissemination event was conducted as part of the 21st Jyväskylä Summer School 2011, and took the form of a course on 'Biogas Technology for Sustainable Second Generation Biofuel Production' from 15-19 Aug 2011. The course was coordinated by Prof Jukka Rintala (MTT) and the majority of presentations given by VALORGAS partners: Charles Banks (Soton), David Bolzonella (UNIVR), Cristina Cavinato (UNIVE) Michael Chesshire (Greenfinch), Prasad Kaparaju (JyU) and the team at Metener, who also hosted a site visit. The programme attracted around 30 participants from 18 different countries.

Due to the success of the above event, a second programme was organised at the 23<sup>rd</sup> Jyväskylä Summer School in 2013 (12-16 Aug). The course title was 'Biogas Technology for Renewable Energy Production and Environmental Benefit' and it was coordinated by Dr Prasad Kaparaju (JyU). Lectures were mainly given by VALORGAS partners: Yue Zhang (Soton), David Bolzonella (UNIVR), Cristina Cavinato (UNIVE), Michael Chesshire (Greenfinch), Prasad Kaparaju (JyU) and Juha Luostarinen (Metener). A field trip to Kalmari biogas plant in Laukaa was hosted by the whole team at Metener. The programme attracted 27 participants from 12 countries.



*Summer school location at JyU*



*Jussi Lantela (Metener) with VALORGAS lecturers and course participants*





Workshop banner



Session participants

### *IIT International Workshop August 2013*

The International Dissemination Workshop on 'Promotion of Biogas Upgrading and Bottling in India and European Union' took place on 22-24 Aug 2013. The event attracted over 200 applicants from countries including India, UK, Kenya, Nepal, Finland, Germany and Australia, out of which around 100 participants were selected. It was the first international event of this scale on this theme at IIT Delhi and was able actively to engage with and reach out to a wide range of policy makers, entrepreneurs and project developers. The programme included technology overviews for India and Europe, success stories and sessions on applications, regulation and commercialisation, with presentations and session chairs from industry and senior staff and advisers at the MNRE.

Technical visits were also conducted to the IIT Delhi experimental gas upgrading and bottling facilities, and to Tohana biogas upgrading plant.

Special VALORGAS sessions were also held at the 6th IWA International Symposium on Anaerobic Digestion of Solid Waste and Energy Crops in Vienna, 28 Aug – 1 Sept 2011 and the 8th APESB/ISWA International Technical Conference on Waste: Waste Management for Resources Sustainability, 15-18 July 2013; with a series of special events in India organised by IIT.

Full details of these, including course materials where relevant, are available on the VALORGAS website (see [www.valorgas.soton.ac.uk/publications.htm](http://www.valorgas.soton.ac.uk/publications.htm))

### **Exploitation**

Key activities for exploitation of the project results include

- Use and dissemination of WebCAT software for collections modelling and assessment, including implementation of sensitivity analysis option
- Further dissemination of project outputs through urban micro-AD networks programme
- Incorporation of findings on digestate use and biosecurity in national guidelines and feed-in to End of Waste criteria
- Further investigation of specific applications for autoclaving with high nitrogen wastes and lignocellulosic residues
- Development of 2-phase hythane process to prototype
- Refinement of microbial population analyses linking characterisation and functionality
- Application and marketing of small-scale biogas upgrading systems and further development of innovations
- Promotion of ILCD node for dissemination of validated data sets
- Application of integrated Aspen Plus and ADM1 models for improved process optimisation and control, and incorporation of novel processes for ammonia removal and dewatering
- Completion of work on digestate separation processes
- Application of mass and energy balance methodologies on full-scale commercial plant

**[www.valorgas.soton.ac.uk](http://www.valorgas.soton.ac.uk)**